

SUMITOMO

SH300-5

- Engine Rated Power (Net) : 154 kW · 209 PS
- Operating weight :
SH300-5 29,100~29,800 kg
- Bucket : ISO/SAE/PCSA Heaped : 1.00~1.30 m³

LEGEST



SUMITOMO (S.H.I.)
CONSTRUCTION MACHINERY
MANUFACTURING CO., LTD.

731-1 Nagnumahara-cho, Inage-ku, Chiba, 263-0001 Japan
For further information please contact: Phone : +81-43-420-1796 Facsimile : +81-43-420-1907

We are constantly improving our products and therefore reserve the right to change designs and specifications without notice. Illustrations may include optional equipment and accessories and may not include all standard equipment.



MADE IN JAPAN

The world knows that Japanese design and manufacturing is the best especially for industrial products. The hydraulic excavator is not the exception when a total integration concept is required in design work involving key components, manufacturing engineering and product quality assurance in the factory.

All SUMITOMO hydraulic excavators are engineered and assembled in SUMITOMO's its one and only factory located in Chiba City, Japan, and distributed to each country in the world. This distinctive feature is unique to SUMITOMO, giving the SUMITOMO machine users total comfort and reliance on product quality.

(Note: Some of the items manufactured and sourced in other countries may be assembled in Japan.)

·The new engine complies with the Emission Regulations U.S. EPA Tier III, and EU Stage IIIA.

·The advanced low noise design complies with the upcoming EU noise regulation 2000/14/EC, STAGE II.

Engine and Hydraulics 04 - 07

- SPACE 5
- SIHIS
- New working mode

Durability 08 - 09

- Stronger boom and arm
- Durable bucket
- Ridged swing frame
- Improved undercarriage

Maintenance 10-11

- High performance hydraulic return filter
- Fuel tank
- Engine oil drain coupler
- Ground level maintenance

Operator Comfort 12 - 13

- Spacious cabin
- Comfortable operator's seat
- Message display from LCD monitor

Safety 14

- Optimised view from cabin
- High -rigidity cabin structure

Customer and Product Support 15

Specifications 16 - 23

Engine and Hydraulics



1 Powerful 2 Economy 3 Clean 4 Silent 5 Strong
 "SPACE5" is a new engine system consisting of five (5) special features.

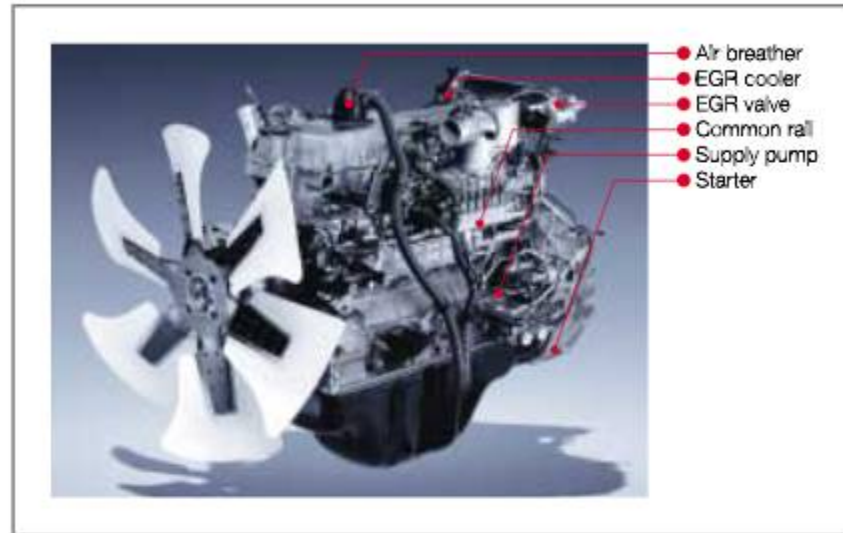

Engine

A newly developed ISUZU engine 6HK1X complies with Emission Regulations U.S. EPA Tier III and EU Stage IIIA. This produces bigger output and torque, and far better fuel consumption than the previous model.

Comparison of engines

	SH290-3	SH300-5	Merit	
Name of engine	ISUZU-6BG1T	ISUZU-6HK1X		
Type	12-valve OHC	24-valve OHC		
Displacement	cc	6,494	7,790	
Number of cylinders - Dia. x Stroke	mm	6-106 x 126	6-116 x 125	
Rated output	kW/min ¹	132/2,200	154/1,800	Higher output (+16%)
Max. torque	Nm/min ¹	600/1,800	850/1,500	Higher torque (+41%)
Size (Length-Width-Height)	mm	1206-814-6-996	1357-995.4-1162.5	
Cylinder block	Bearing CAP	Ladder frame	High rigidity/low noise	
Fan belt	V-Belt	V-Belt		

Common Rail Type High-Pressure Fuel Injection System

The system is equipped with a common rail type high-compression fuel injection system, which permits high-precision injection from multiple injection under ultra high-pressure of more than 1600 atm. Precise control of injection time and injection quality at that rate of 1/1000 second optimizes combustion, improves combustion efficiency, and reduces PM (particulate matter) substantially.

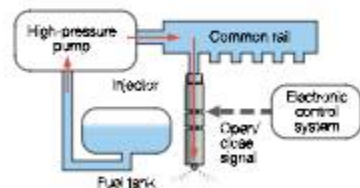

Cooled EGR System

The EGR (Exhaust Gas Recirculation) mixes the gas, which is once exhausted, with the air that is taken in so as to lower the combustion temperature, thereby reducing NOx (nitrogen oxide). Adoption of the cooled EGR system, in which a water-cooling cooler is installed in the middle of the re-circulation pipe, permits further decrease in the suction temperature, ensuring a better NOx reduction effect than the ordinary EGR.

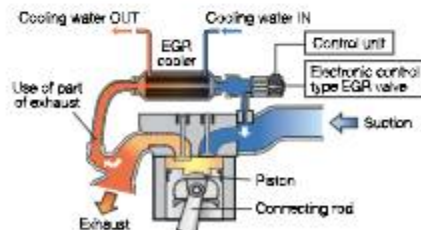

24 valve OHC Turbo Engine with Inter-Cooler

When the inter-cooler cools the intake air, which is compressed by a turbocharger and has reached a high temperature, the density of the air increases and the suction efficiency increases. Therefore, NOx and PM can be reduced substantially, permitting high output and improvement of fuel efficiency simultaneously.

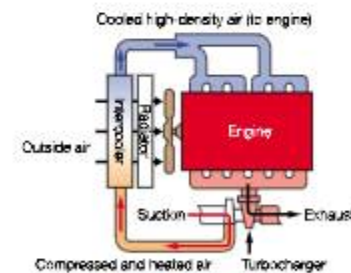

- 9% increase in bucket digging force
- 7% improvement in arm closing speed under heavy excavation
- 20% increase in bucket closing speed
- 6% increase in traction force

* As compared with SH290-3

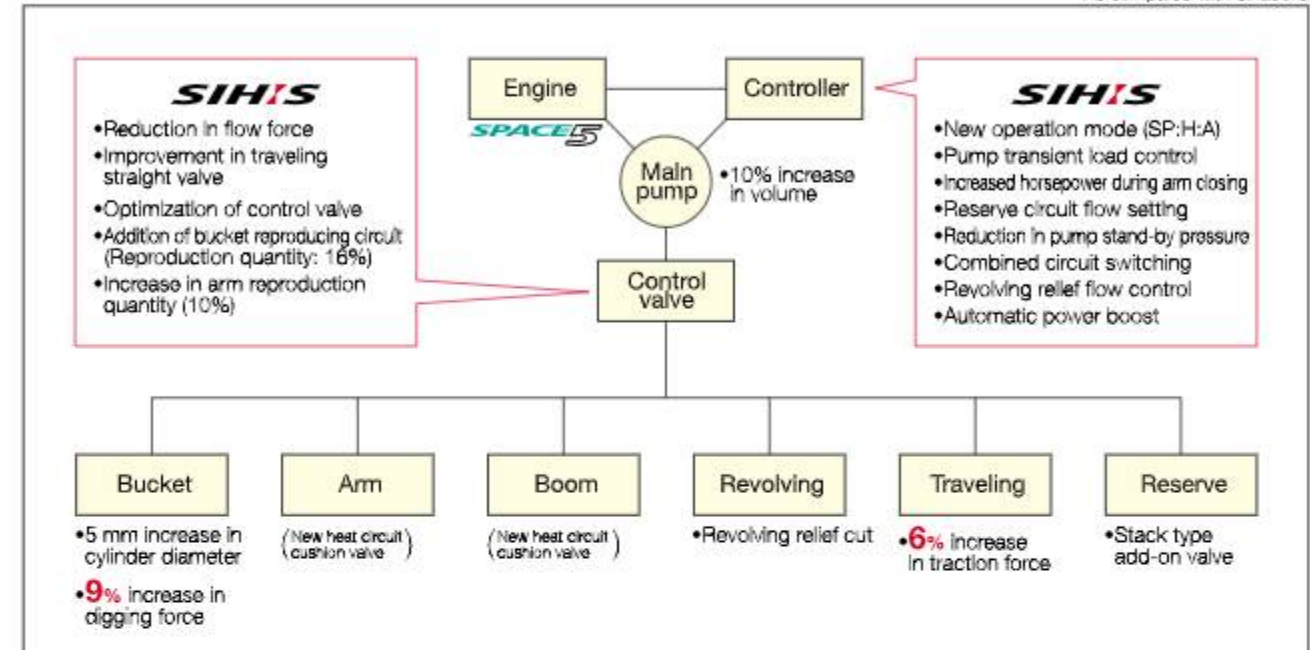

Real Digging Power

The true digging force can not be expressed by a maximum digging power figure listed in sales materials. With a much improved hydraulic system and by adopting a larger arm cylinder, the arm-in motion speed slowdown is minimized by seven percent (7%) in comparison with the previous model. The digging power when combined with the attachment speed in motion convey to the operators "real digging power".

SP (Speed Priority mode)

SP "Speed Priority" mode has been developed, which is not available in competitors models nor in our previous model. This will create biggest productivity in its class with more economical fuel efficiency even in comparison with the Heavy mode of our previous model. In addition, the throttle control is simple to use.

- SP mode: 8% increase in workload
- * As compared with SH290-3 (H mode)

Automatic Power Boost

The digging power increases automatically in quick response to the working conditions without switching operations during heavy-duty digging work. It is SUMITOMO'S original design and continues for 8 seconds.

Quick and Smooth Control Response

A total review of the hydraulic circuit and miscellaneous hydraulic settings guarantee speedy and precise operation through a smooth control lever.

Multifunctioning Capability for Upper and Travel Operation

With the new hydraulic circuit, travel motion slowdown will not be experienced even during the combined operation of attachment and swing motion when traveling.



Engine and Hydraulics

The integration of the new engine system "SPACE 5" and new hydraulic system "SIH:S" has created 15% fuel efficiency improvement in comparison with our conventional model.

New engine system



5%

+

New hydraulic system



10%

||

15% reduction in fuel consumption compared to SH290-3 (H mode)

*The fuel consumption may vary from time to time depending on site and working conditions, operator skill and other circumstances.

Greater productivity and increased working efficiency



Hydraulic Oil Flow Control

SUMITOMO unique design

In the case of sudden lever movement and high load activation, the newly developed hydraulic control system reduces the main pump oil flow intentionally and keeps the engine speed at a constant level. This enables a reduction in fuel consumption. In addition, this also reduces the level of exhaust smoke due to excessive fuel injection.

Reduction of Hydraulic Oil Flow at Swing

SUMITOMO unique design

The hydraulic oil quantity required at the time of sudden swing motion is limited. The new hydraulic system can start the oil flow volume at the minimum level and then allow it to increase on demand. This optimum oil flow control significantly improves the fuel efficiency.

Reduction in Pump Stand-by Pressure

SUMITOMO unique design

Reducing pump oil flow pressure during stand-by minimizes the load on the engine. This also improves fuel consumption.

Increased Pump Efficiency

The new modified hydraulic pump structure lowers the oil leak volume in the pump which means improved pump efficiency and improved engine fuel efficiency.

Mode Selection by Throttle

Mode selection by pressing the button in our previous model sometimes cause inconveniences for the operator. The throttle control system has been upgraded and the new system "A" mode which stands for "Adjustment Mode" now covers the 3 previous modes of "Auto, Standard and Light". In addition there is "H" (Heavy) mode and "SP" (Speed Priority) mode, and the hydrostatic pump oil flow will be regulated automatically in each of the 3 modes respectively.

The SP mode is added to the operation mode. Furthermore, the A (Adjustment) mode is added to the SP and H modes, respectively. In comparison with the H mode of Dash 3, the SP mode has reduced the fuel consumption by 9%, and the H mode of Dash 5 has reduced the fuel consumption by 15% as compared with Dash 3.



Throttle knob position	1	2	3	4-8	9-15
Engine speed	1,800	1,700	1,600	1,599-1,300	1,299-1,000
Operation mode	SP	H		A	
Automatic power boost	Automatic			Constant	

SH290-3 (Previous model)		SH300-5	
H	HEAVY (Speed priority)	SP	SPEED PRIORITY
A	AUTO (Simultaneous pursuit of speed and fuel efficiency)	H	HEAVY (Simultaneous pursuit of speed and fuel efficiency)
S	STANDARD (Fuel priority)	A (13 steps)	ADJUSTMENT (Ordinary operation / Fine operation / Lifting operation)
L	LIGHT/LIFT (Fine operation / Lifting operation)		

Reduction in fuel consumption by 9%
Reduction in fuel consumption by 15%
Reduction in fuel consumption by 5-10%

↑ Working speed

Durability

Boom & Arm

1. The boom structure is now 2 pieces instead of 3.
2. High strength castings are used for the boom base and arm end.
3. One size larger piping is used for the boom boss area.
4. Thicker steel plate is used for added strength.

The improved boom plate structure has reduced the number of weld sections that reduce the strength, thereby improving the quality.

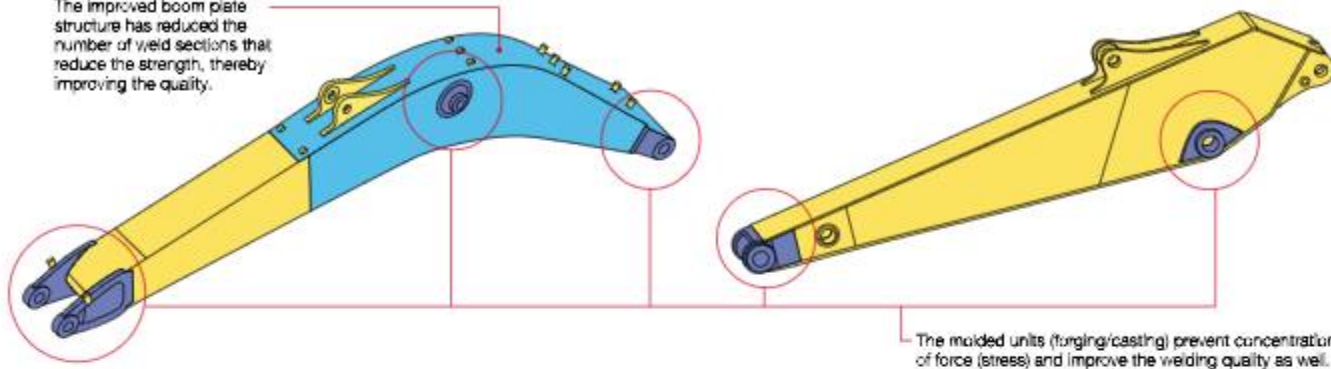

Bucket

A one piece wear plate covers the weldment area to increase the wear life of the bucket.



■ Cross section
Protection of weld bottom plate and flattening of bottom plate by changing the bottom plate weld structure

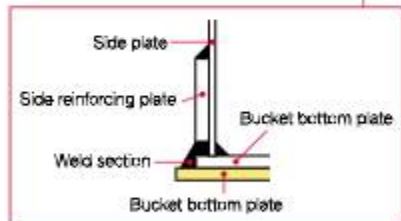

Swing Frame

Reinforced plate on "A" frame is extended and the swing frame base is made in one-piece steel plate.

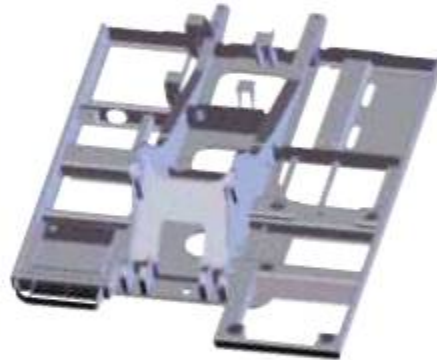

Revolving frame



A frame

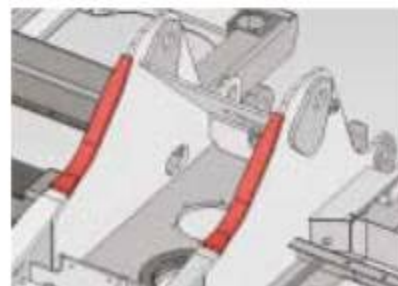

Ridged Upper Side Section Frame 5% increase in rigidity

A closed -section "D" shape structure with thicker plate reduces stress and is high impact resistant.

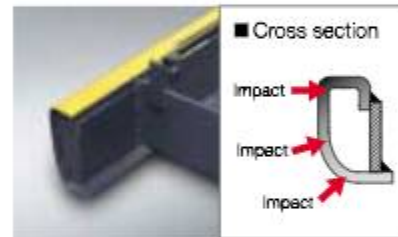

Undercarriage

- 1 **Link shoe**
M-type seal
- 2 **Center joint**
Prevention of bolt loosening
- 3 **Recoil Spring**
Use of high hardness material
- 4 **Idler**
Reinforced boss
- 5 **Carrier roller**
Tread machining addition of jaw
- 6 **Center guard**
Change of structure and bigger size
- 7 **Track roller**
Tread machining addition of jaw

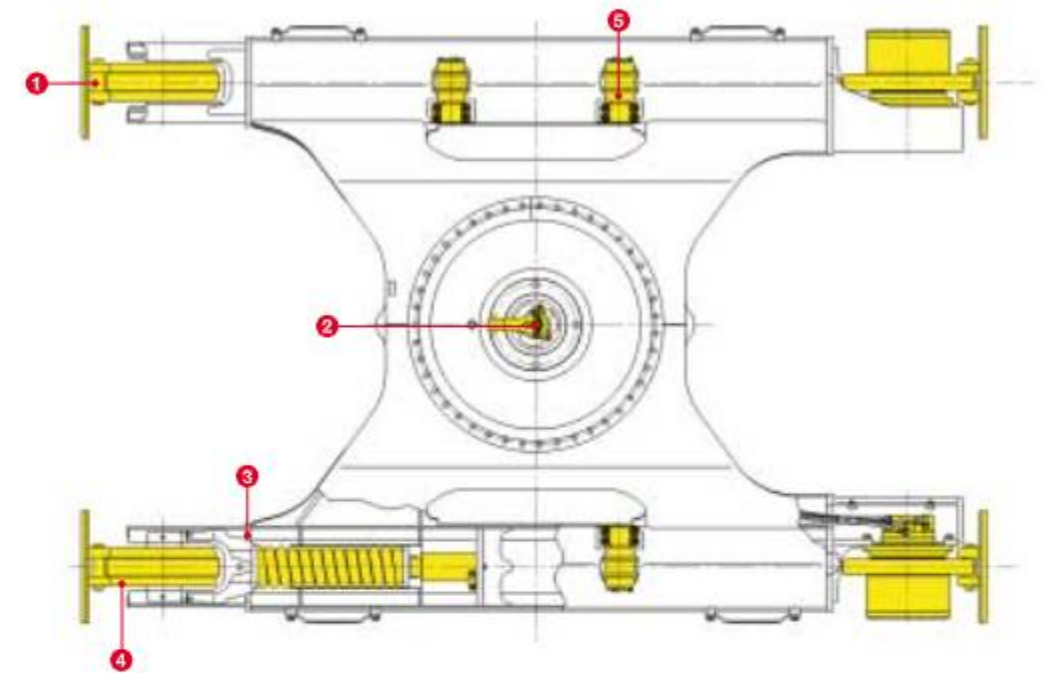
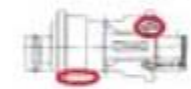
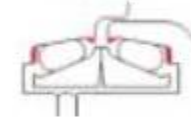

Maintenance

High-Performance Return Filter

The hydraulic oil change interval is 5,000 hours, and the return filter change interval is 2,000 hours. One high performance return filter keeps the same level of filtering effect as a nephron.

- Hydraulic oil change : **5,000 hours**
- Life of filter : **2,000 hours**

* The oil and filter change interval depends on the working conditions.



The High-Performance Return Filter is made more precisely to condense the Nephron filter function.

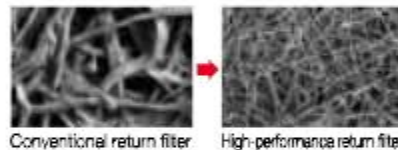

Conventional return filter High-performance return filter

Fuel Tank

Stainless steel is used for the strainer that prevents dust entering during re-fueling. Furthermore, a maintenance hole is provided to permit easy periodical maintenance.

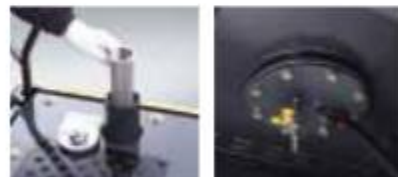

Stainless steel strainer Maintenance hole for cleaning

Engine Oil Drain Coupler

The engine oil pan is provided with a drain coupler. This makes easier to do drain work and preventing oil from spattering with an attached drain hose.



EMS (Easy Maintenance System) as Standard

SUMITOMO's new improved EMS keeps the pins and bushes fully lubricated at all times and prevents rattling. This system significantly extends the service life of the pins and bushes.

The interval of greasing around the bucket is 250 hours, and for the other sections is 1,000 hours, keeping the joints lubricated for a long time and extending the service life of parts by reducing abrasion and rattling.

- Bucket greasing interval : **250 hours**
- Greasing interval for other sections : **1,000 hours**

* The greasing interval depends on the working conditions.

EMS bushing

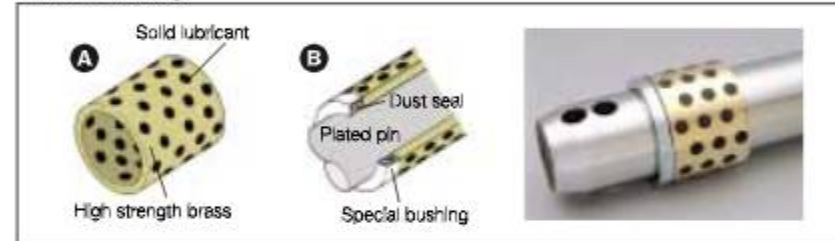

① A solid lubricant embedded in high strength brass forms a layer on the bushing surface to prevent contact between metals, maintaining an excellent lubricated state to reduce abrasion of joints.

② The surface of the pin is plated to increase the surface hardness and improve the wear resistance accordingly.

Steel EMS bushing



Steel EMS is installed around the bucket



Precautionary use of EMS

- ① Grease is enclosed, however, greasing is necessary every 1000 hours or six months depending on the level of dusting conditions.
- ② Greasing is also necessary after any components have been submerged underwater for prolonged periods.
- ③ Greasing is also recommended after use with hydraulic breakers, crushers or other high impact attachments such as Rock Saws etc.
- ④ Bucket pins should be cleaned thoroughly when removing or attaching new buckets.

Ground Level Access to Engine Area Improves Preventative Maintenance.

Parts cleaning and maintenance are possible from the ground without climbing onto the upper structure of the excavator body.



•Remote fuel and oil filters

A fuel prefilter is provided as standard equipment to reduce trouble due to fuel clogging. In addition, the fuel and oil filters are installed at ground-accessible location to facilitate replacement.

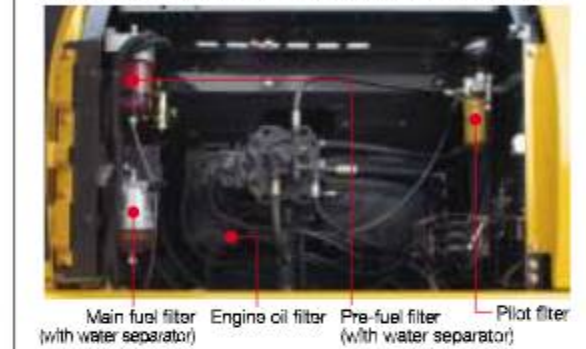

Main fuel filter (with water separator) Engine oil filter Pre-fuel filter (with water separator) Pilot filter

•Parallel installation of radiator and oil cooler

A space provided at the front of the inter cooler and the tilting condenser facilitates cleaning.

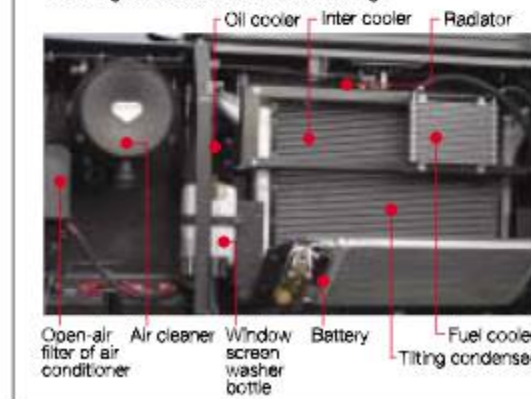

Open-air filter of air conditioner Air cleaner Window screen washer bottle Battery Tiltng condenser Fuel cooler

•Ease of cleaning around radiator

The radiator and oil cooler are arranged in parallel. Furthermore, a space has been provided at the front of the inter cooler and a tilting air condenser has been adopted to substantially facilitate cleaning. Dust build up can be removed easily and prevent overheating.

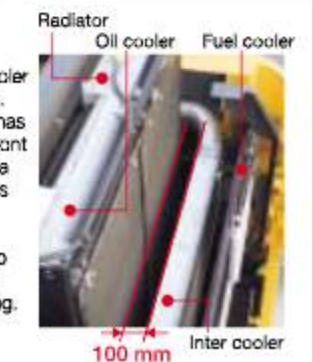

Radiator Oil cooler Fuel cooler Inter cooler 100 mm

Operator Comfort

SUMITOMO's Redesigned Cabin and Seat for Optimum Operator Comfort

The seat reclining system allows the operator to lay the seat flat and to rest on site without removing the headrest.



Operating Positions of Sliding Seat and Tilting Console

In addition to the tilting console that is adjustable in four steps vertically, the increased sliding distance ensures optimum working conditions.



New Water-repelling Operator's Seat

SUMITOMO
unique design

A rainwater and dust-resistant, water-repelling operator's seat has been adopted.

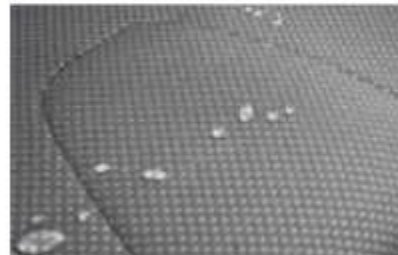

The Suspension Seat Eliminates Vibration



Air suspension (Option)

Simple to Read LCD Monitor and Switch Panel

In addition to the monitor that is easy to read during daytime as well as nighttime by changing the backlight to white, a simple and convenient universally designed switch panel is provided.



Warning message

1. OVER HEAT
2. ALTERNATOR
3. LOW FUEL
4. LOW OIL PRESSURE
5. LOW COOLANT
6. ELEC.PROBLEM
7. OVER LOAD (option)
8. AIR FILTER
9. CHECK ENGINE
10. BOOST TEMP. HIGH
11. CHECK BREAKER FILTER (option)

Active condition message

1. ENG.PRE HEAT
2. AUTO WARM UP
3. ENG.IDLING
4. POWER UP
5. ENGINE STOP

Language menu

Japanese	Danish
English	Norwegian
Thai	Swedish
Chinese	Finnish
German	Turkish
French	Arabic
Italian	Malay
Spanish	Indonesian
Portuguese	(Pictograph)
Dutch	

Flow Setting in 10 Patterns and Switching of Combined Circuit

The switch panel in the cab permits setting the flow rate for work with a maximum of ten different special attachments in advance. A circuit change for the breaker and crusher is also possible in the cab.



Fluid Filled Cab Mounts

Four fluid cab mounts reduce vibration and impact transmitted to the cabin, and improve the operators' sitting quality and reduce operator fatigue.

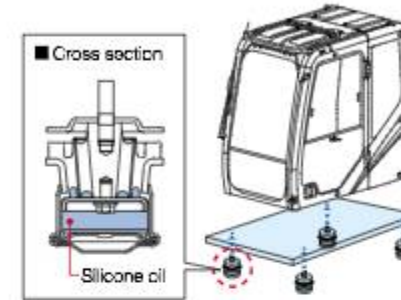

Automatic Air Conditioner with Round Outlets for Increased Comfort

The air outlets of the air conditioner are provided with round grills with wide adjusting angles. The efficiency of the air conditioner has been increased by pressurizing the cab to make it airtight, providing a comfortable space.



ISO-compliant Pressurized Cab to Prevent Dust Entry

The sealed and pressurized (sealing by pressure) cab prevents entry of dust from outside.

Convenient One-touch Muting of AM/FM Radio

An AM/FM radio is provided as standard equipment. The mute switch on the left lever permits one-touch muting of the radio.



The wide view increases the safety of work

In addition to the wide front view, the down-right view is also made larger to enhance the safety of work.



Anti-theft Alarm System

SUMITOMO's unique anti-theft system can be activated by your SUMITOMO distributors at the time of purchase.



Anti-theft alarm system

Safety Equipment in case of an Emergency



Emergency stop switch

New Gate Lock Lever and Console Tilt-up Function

The console tilt-up function permits easy entry and exit.



Safe and Easy Entry into and Exit from the Cab

A large handrail for easy opening/closing of the door and a non-slip plate are installed to permit the operator to get in and out of the cab easily.



Large handrail



New non-slip plate

High-rigidity Cabin

The new cabin structure provides advanced operator protection.

- About **3 times** greater rigidity
- * As compared with SH290-3

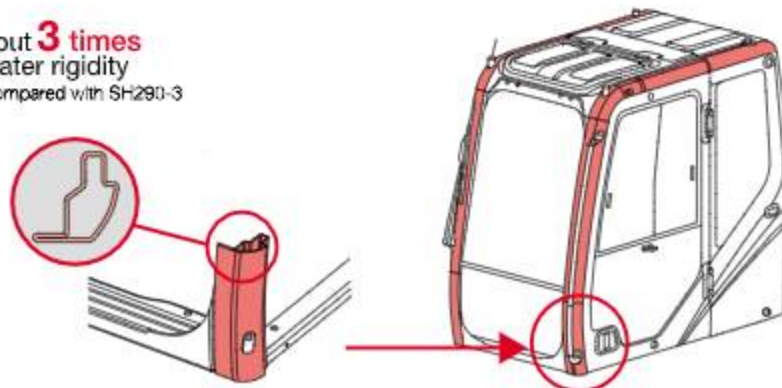

Easy Access to the Upper Structure

A large step and handrail, as well as a non-slip plate, minimize the effort when climbing on and off the upper structure.



Front-right large step



Non-slip plate



ISO-compliant large handrail

SUMITOMO's total commitment to product and customer support has enabled it grow into a world renowned manufacturer of hydraulic excavators. Supported by a global sales and service network of over four hundred distributors representing hydraulic excavators manufactured by SUMITOMO, the company supply 70% of total production from Japan to all five continents.

A spread of over one thousand outlets offering excellent parts and service support has global coverage ensuring SUMITOMO hydraulic excavator users have at their disposal Regional Spare Parts Centers, technical repair shops and service vehicles carrying all the necessary equipment to service and repair any hydraulic excavator manufactured by SUMITOMO.

SUMITOMO aims to produce the right products to meet all work applications and at the same time provide the highest level of more training and education to ensure complete product support quality throughout the service network in the world.

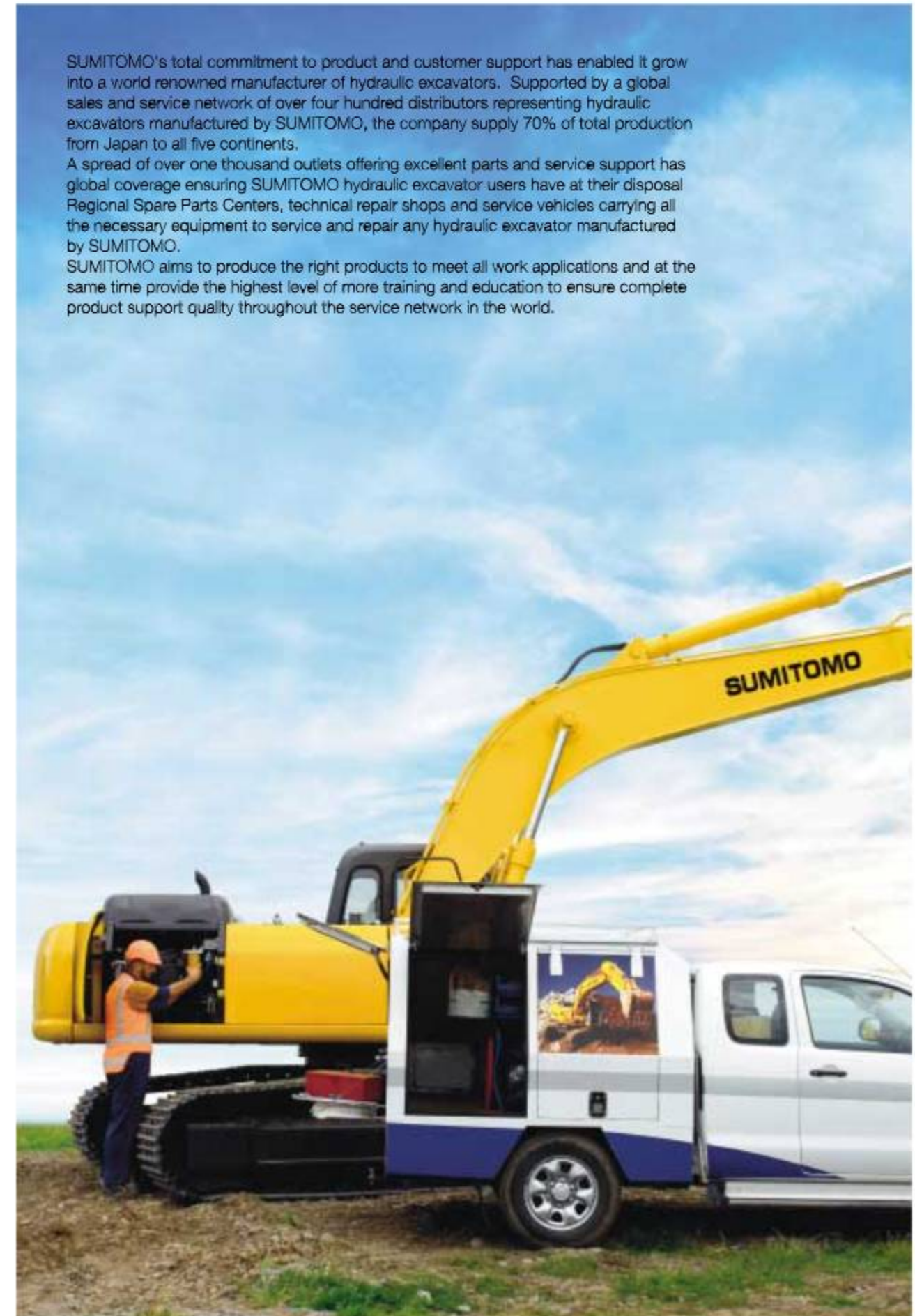

Specifications

SH300-5 Technical Data

Engine

Two variable displacement axial piston pumps, one gear pump for pilot controls and electronic-controlled engine of SPACE5 and SIH:S with New Hydraulic System Includes: three working modes (SP, H, A) one-touch/automatic idling system, automatic power-boost, speed assistance system, power-swing system.

SH300-5	
Model	ISUZU AH-6HK1X
Type	Water-cooled, 4-cycle, overhead valve, 6-cylinder in line, direct injection (electric control), turbo-charged diesel engine.
Rated output	154 kW (209 PS)/1,800 min ⁻¹
Maximum torque	850 N·m at 1,500 min ⁻¹
Piston displacement	7,790 cc
Bore and stroke	115 mm x 125 mm
Starting system	24 V electric motor starting
Alternator	24 V, 50 A
Fuel tank	450 liters
Air filter	Double element

Hydraulic pumps

Two variable displacement axial piston pumps provide power for attachment, swing and travel.

SH300-5	
Maximum oil flow	2 x 243 liters/min
Pilot pump max. oil flow	27 liters/min

Hydraulic motors

For travel: Two variable displacement axial piston motors.
For swing: One fixed displacement axial piston motor.

Relief valve settings

Boom/arm/bucket 39.2 Mpa(400 kgf/cm²)<Holding pressure>
Boom/arm/bucket 34.3 Mpa(350 kgf/cm²)<Working pressure>
Boom/arm/bucket 37.3 Mpa(380 kgf/cm²)with Power-up<Working pressure>
Swing circuit 29.4 Mpa(300 kgf/cm²)
Travel circuit 34.3 Mpa(350 kgf/cm²)

Control valve

One 4-spool valve and one 5-spool valve with auxiliary spool.

Oil filtration

Return filter 6 microns
Pilot filter 8 microns
Suction filter 105 microns

Hydraulic cylinders

Cylinder	Qty	Bore x Rod Diameter x Stroke
Boom	2	140 mm x 95 mm x 1369 mm
Arm	1	150 mm x 105 mm x 1569 mm
Bucket	1	135 mm x 90 mm x 1078 mm

Double-acting, bolt-up type cylinder tube-end; hardened steel bushings installed in cylinder tube and rods ends.

Cab & Controls

Cab mounted on 4 fluid mountings. Features include safety glass front, rear and side windows, reclining/sliding cloth upholstered suspension seat with headrest and armrest, cigarette lighter, pop-up skylight window, and intermittent wiper with washer. Front window slides upward for storage and the lower front window is removable. Control levers are located in 4 positions tilting control consoles. Reliable soft-touch switches. Easy-to-read Full-dot LCD monitor keeps operation in touch with critical machine functions.

Swing

Planetary reduction powered by axial piston motor; internal ring gear with grease cavity for pinion. Swing bearing is single-row shear type ball bearing. Dual stage relief valves for smooth swing deceleration and stops. Mechanical disc swing brake.

SH300-5	
Swing speed	0~10.2 rpm
Tail swing radius	3,160 mm
Swing torque	92.5 kN·m(9,432 kgf·m)

Undercarriage

X-style carbody is integrally welded for strength and durability. Grease cylinder track adjusters with shock absorbing springs. Undercarriage with lubricated rollers and idlers.

Type of shoe: sealed link shoe

Upper rollers -

Heat treated, mounted on steel bushings with fluorine resin, sealed for lifetime lubrication.

Lower rollers -

Heat treated, mounted on steel bushings with leaded tin bronze casting, sealed for lifetime lubrication.

Track adjustment -

Idler axles adjusted with grease cylinder integral with each side frame; adjustment yoke mechanism fitted with heavy duty recoil spring.

Number of rollers and shoes on each side

SH300-5	
Upper rollers	2
Lower rollers	9
Track shoes	50

Travel System

Two-speed independent hydrostatic system with compact axial motors for increased performance. Hydraulic motor powered output shaft coupled to a planetary reduction unit and track sprocket. All hydraulic components mounted within the width of side frame.

Travel speed can be selected by switch panel.

Hydraulically released disc parking brake is built each motor.

SH300-5	
Travel speed	High 5.6 km/h Low 3.2 km/h
Maximum traction force	233.2 kN(23,779 kgf)

Lubricant & Coolant Capacity

SH300-5	
Hydraulic system	300 liters
Hydraulic oil tank	147 liters
Fuel tank	450 liters
Cooling system	29 liters
Final drive case(per side)	9.1 liters
Swing drive case	6.0 liters
Engine crank case	38 liters

Auxiliary hydraulic system

SH300-5			
Auxiliary piping type (option)	For Breaker	For Double (breaker & crusher) acting	For D/A + Second option line
Arm type	STD	STD	STD
Bucket linkage type	HD	HD	HD
Auxiliary hydraulic pump flow	243 liters/min	486 liters/min	486+60 liters/min

Bucket

Model	SH300-5		
Bucket capacity (ISO/SAE/PCSA heaped)	1.00 m ³	1.10 m ³	1.30 m ³
Bucket capacity (CECE heaped)	0.85 m ³	0.90 m ³	1.10 m ³
Bucket type	STD	STD	STD
Number of teeth	5	5	5
Width unit:mm	V/ith side cutter 1 276	1 360	1 560
	V/ithout side cutter 1 175	1 210	1 410
Weight unit:kg	841	871.8	944.5
Combination	2.65 m arm	●	○
	3.18 m arm	●	○
	3.66 m arm	○	○

○ Standard bucket (Suitable for materials with density up to 1,800 kg/m³ or less)

● Suitable for materials with density up to 2,000 kg/m³ or less

○ Suitable for materials with density up to 1,600 kg/m³ or less

Weight & Ground Pressure

Model	SH300-5			
Shoe type	Shoe width	Overall width	Operating weight	Ground pressure
Triple grouser shoe	600 mm	3 200 mm	29 100 kg	56 kPa
	700 mm	3 300 mm	29 500 kg	49 kPa
	800 mm	3 400 mm	29 800 kg	43 kPa

Digging Force

Model	SH300-5			
Arm length		2.65 m	3.18 m	3.66 m
Bucket digging force	ISO 6015	175 kN (190 kN)	175 kN (190 kN)	175 kN (190 kN)
	SAE: PCSA	156 kN (169 kN)	156 kN (169 kN)	156 kN (169 kN)
Arm digging force	ISO	140 kN (153 kN)	122 kN (132 kN)	110 kN (119 kN)
	SAE: PCSA	135 kN (148 kN)	118 kN (128 kN)	107 kN (116 kN)

Lifting Capacity

- Notes: 1. Ratings are based on SAE J150 10567
 2. Lifting capacity does not exceed 75% of tipping load with the machine on firm, level ground or 87% full hydraulic capacity.
 3. The load point is a hook (not standard equipment) located on the back of the bucket.
 4. *Indicates load limited by hydraulic capacity.
 5. 0m = Ground.

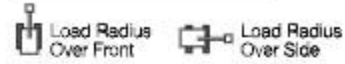

Unit : kg

SH300-5		SHOE : 600 (mm)G BUCKET : SAE/PCSA 1.30 (m³)		ARM LENGTH - 3.66 (m) MAXIMUM REACH - 9.61 (m)		BOOM : 6.15 (m)																		
Bucket Hook Height	Max. Radius	Radius of Load																						
		9 m	8 m	7 m	6 m	5 m	4 m	3 m	2 m	Min. Radius														
8 m	3 579* 7.43 3 579* 7.43											4 089* 7.19 4 089* 7.19												
7 m	3 465* 8.16 3 465* 8.16	3 861* 3 861*										5 036* 7.24 5 036* 7.24												
6 m	3 428* 8.71 3 428* 8.71	4 936* 4 936*										5 836* 7.04 5 836* 7.04												
5 m	3 455* 9.11 3 455* 9.11	3 810* 3 810*	5 746* 4 783	6 598* 6 039									6 808* 6.54 6 777 6.54											
4 m	3 537* 9.39 3 482 9.39	4 755* 3 772	6 616* 4 666	7 296* 6 843	7 928* 7 538							8 282* 6.56 8 282* 6.56												
3 m	3 679* 9.56 3 299 9.56	5 526* 3 680	7 078 4 511	7 927* 5 625	8 692* 7 204	10 389* 9 625	12 682* 12 662*	17 858* 17 858*				7 845* 2.20 7 845* 2.20												
2 m	3 887* 9.61 3 192 9.61	5 705 3 582	6 915 4 363	8 571* 5 405	9 863* 6 871	11 877* 9 094	15 356* 12 684	10 608* 10 608*				4 400* 2.45 4 400* 2.45												
1 m	4 180* 9.67 3 162 9.67	6 605 3 490	6 783 4 226	8 366 5 204	10 714* 8 577	13 126* 8 649	17 187* 12 183	8 051* 8 051*				3 494* 2.24 3 494* 2.24												
0 m	4 586* 9.41 3 180 9.41	5 523 3 415	6 636 4 109	8 180 5 038	10 462 6 345	13 972* 8 328	17 513* 11 756	8 681* 8 681*	4 816* 4 816*	4 797* 1.99	5 491* 1.95													
-1 m	6 158* 9.14 3 286 9.14	5 469 3 365	6 644 4 025	8 046 4 918	10 277 8 184	13 981 8 127	17 895* 11 639	10 340* 10 340*	7 015* 7 015*	6 997* 1.99	7 003* 1.53													
-2 m	6 684 8.75 3 490 8.75	6 494 3 979 7 967 4 848										10 173 6 089	13 841 8 027	18 153* 11 460	12 576* 12 576*	9 279* 9 279*	9 259* 1.99	8 283* 1.40						
-3 m	6 252 8.22 3 837 8.22	6 498 3 983 7 948										4 831 10 145	6 069 13 822	8 010 17 340*	11 483 15 348*	15 349* 11 747*	11 747*	11 725*	1.99	10 561* 1.40				
-4 m	7 206 7.51 4 420 7.51	8 000 4 878										10 194 8 112	12 934* 8 071	16 972* 11 694	18 833* 18 833*	14 560* 14 560*	14 534*	1.99	13 085* 1.40					
-5 m	8 135* 6.57 5 475 6.57											9 246* 6 237 11 327* 8 217				13 898* 11 800	17 432* 17 432*	17 926* 17 926*	17 891*	1.99	16 272* 1.50			
-6 m	8 053* 5.28 7 817 5.28															8 637* 8 488				10 752* 10 752*	13 248*	13 248*	13 771* 2.82	13 771* 2.82

- Notes: 1. Ratings are based on SAE J150 10567
 2. Lifting capacity does not exceed 75% of tipping load with the machine on firm, level ground or 87% full hydraulic capacity.
 3. The load point is a hook (not standard equipment) located on the back of the bucket.
 4. *Indicates load limited by hydraulic capacity.
 5. 0m = Ground.

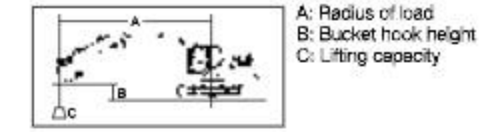

Unit : kg

SH300-5		SHOE : 700 (mm)G BUCKET : SAE/PCSA 1.00 (m³)		ARM LENGTH - 3.66 (m) MAXIMUM REACH - 9.61 (m)		BOOM : 6.15 (m)																		
Bucket Hook Height	Max. Radius	Radius of Load																						
		9 m	8 m	7 m	6 m	5 m	4 m	3 m	2 m	Min. Radius														
8 m	3 579* 7.43 3 579* 7.43											4 089* 7.19 4 089* 7.19												
7 m	3 465* 8.16 3 465* 8.16	3 861* 3 861*										5 036* 7.24 5 036* 7.24												
6 m	3 428* 8.71 3 428* 8.71	4 936* 4 936*										5 836* 7.04 5 836* 7.04												
5 m	3 455* 9.11 3 455* 9.11	3 810* 3 810*	5 746* 4 639	6 598* 6 104								6 808* 6.54 6 808* 6.54												
4 m	3 537* 9.39 3 528 9.39	4 755* 3 821	6 616* 4 712	7 296* 6 909	7 928* 7 618						8 282* 6.56 8 282* 6.56													
3 m	3 679* 9.56 3 344 9.56	5 526* 3 728	7 166 4 567	7 927* 5 691	8 692* 7 284	10 388* 9 727	12 662* 12 662*	17 858* 17 858*				7 845* 2.20 7 845* 2.20												
2 m	3 887* 9.61 3 237 9.61	5 779 3 631	7 002 4 418	8 571* 5 471	9 863* 6 951	11 877* 9 196	15 356* 13 025	10 608* 10 608*				4 400* 2.45 4 400* 2.45												
1 m	4 180* 9.67 3 197 9.67	5 680 3 539	6 850 4 280	8 469 5 270	10 714* 8 657	13 126* 8 751	17 187* 12 326	8 051* 8 051*				3 494* 2.24 3 494* 2.24												
0 m	4 586* 9.41 3 226 9.41	5 598 3 463	6 723 4 166	8 284 5 104	10 592 6 425	13 972* 8 430	17 513* 11 899	8 681* 8 681*	4 816* 4 816*	4 797* 1.99	5 491* 1.95													
-1 m	6 158* 9.14 3 333 9.14	5 544 3 413	6 631 4 080	8 180 4 984	10 408 6 264	14 136 8 229	17 895* 11 681	10 340* 10 340*	7 015* 7 015*	6 997* 1.99	7 003* 1.53													
-2 m	6 761 8.75 3 841 8.75	6 581 4 035 8 071 4 914										10 304 6 174	14 016 8 129	18 153* 11 602	12 576* 12 576*	9 279* 9 279*	9 259* 1.99	8 283* 1.40						
-3 m	6 338 8.22 3 891 8.22	6 585 4 039 8 053 4 897										10 276 6 149	13 887* 8 113	17 340* 11 624	15 348* 15 348*	11 747* 11 747*	11 725*	1.99	10 561* 1.40					
-4 m	7 301 7.51 4 481 7.51	8 106 4 944										10 325 6 192	12 934* 8 174	16 972* 11 736	18 833* 18 833*	14 560* 14 560*	14 534*	1.99	13 085* 1.40					
-5 m	8 135* 6.57 5 546 6.57											9 246* 6 317 11 327* 8 320				13 898* 11 942	17 432* 17 432*	17 926* 17 926*	17 891*	1.99	16 272* 1.50			
-6 m	8 053* 5.28 7 912 5.28															8 637* 8 680				10 752* 10 752*	13 248*	13 248*	13 771* 2.82	13 771* 2.82

SH300-5		SHOE : 600 (mm)G BUCKET : SAE/PCSA 1.10 (m³)		ARM LENGTH - 3.18 (m) MAXIMUM REACH - 9.10 (m)		BOOM : 6.15 (m)																	
Bucket Hook Height	Max. Radius	Radius of Load																					
		9 m	8 m	7 m	6 m	5 m	4 m	3 m	2 m	Min. Radius													
8 m	4 336* 6.75 4 336* 6.75											4 406* 6.72 4 406* 6.72											
7 m	4 211* 7.54 4 211* 7.54	5 463* 5 463*										5 809* 6.77 5 809* 6.77											
6 m	4 191* 8.13 4 191* 8.13	4 617* 4 617*										6 547* 6 128	6 862* 6.54 6 880 6.54										
5 m	4 252* 8.66 4 205 8.66	5 968* 4 755										7 298* 6 986	7 769* 7 740	7 783* 5.96 7 783* 5.96									
4 m	4 389* 8.86 3 879 8.86	7 154* 4 642	7 816* 5 803	8 584* 7 453	9 741* 9 741*							10 337* 4.62 10 337* 4.62											
3 m	4 607* 9.04 3 867 9.04	4 788* 3 693	7 068 4 511	8 410* 6 600	9 612* 7 137	11 233* 9 477	14 222* 13 492	16 288* 16 288*				6 770* 2.60 6 770* 2.60											
2 m	4 920* 9.10 3 546 9.10	5 457* 3 611	6 922 4 378	8 571 5 400	10 418* 8 631	12 638* 8 990	16 517* 12 643	7 144* 7 144*				4 879* 2.81 4 879* 2.81											
1 m	5 359* 9.05 3 506 9.05	5 645 3 535	6 789 4 258	8 372 5 221	10 705 6 570	13 722* 8 625	17 982* 12 075	8 948* 8 948*				4 332* 2.64 4 332* 2.64											
0 m	6 696 8.88 3 548 8.88	6 683 4 161 8 214 6 080										10 481 8 375	14 200 8 344	18 985* 11 770	8 682* 8 682*	8 652* 2.38	8 652* 2.38						
-1 m	6 939 8.60 3 687 8.60	6 613 4 097 8 108 4 985										10 336 6 249	14 024 8 196	18 328* 11 640	11 057* 11 057*	7 849* 7 849*	7 833* 1.99	8 554* 1.94					
-2 m	6 382 8.18 3 952 8.18	6 690 4 076 8 058 4 940										10 268 6 190	13 956 8 140	17 916* 11 621	13 881* 13 881*	10 585* 10 546*	1.99	8 668* 1.40					
-3 m	7 137 7.60 4 409 7.60	8 070 4 961										10 276 6 195	13 632* 8 180	16 828* 11 666	17 246* 17 246*	13 455* 13 432*	1.99	12 260* 1.40					
-4 m	8 472 6.83 5 212 6.83											10 238* 6 272 12 404* 8 256				15 158* 11 839	18 932* 18 932*	16 732* 16 703*	1.99	15 145* 1.40			
-5 m	8 764* 5.78 6 803 5.78															10 387* 8 447				12 878* 12 091	15 547* 15 547*	18 935* 2.16	18 935* 2.16

SH300-5		SHOE : 700 (mm)G BUCKET : SAE/PCSA 1.10 (m³)		ARM LENGTH - 3.18 (m) MAXIMUM REACH - 9.10 (m)		BOOM : 6.15 (m)																	
Bucket Hook Height	Max. Radius	Radius of Load																					
		9 m	8 m	7 m	6 m	5 m	4 m	3 m	2 m	Min. Radius													
8 m	4 336* 6.75 4 336* 6.75											4 406* 6.72 4 406* 6.72											
7 m	4 211* 7.54 4 211* 7.54	5 463* 5 463*										5 809* 6.77 5 809* 6.77											
6 m	4 191* 8.13 4 191* 8.13	4 617* 4 617*										6 547* 6 194	6 862* 6.54 6 952 6.54										
5 m	4 252* 8.66 4 252* 8.66	5 968* 4 811										7 298* 6 052	7 759* 7 759*	7 783* 5.96 7 783* 5.96									
4 m	4 389* 8.86 3 928 8.86	7 154* 4 698	7 816* 5 869	8 584* 7 533	9 741* 9 741*							10 337* 4.62 10 337* 4.62											
3 m	4 607* 9.04 3 715 9.04	4 788* 3 741	7 156 4 587	8 410* 6 686	9 612* 7 217	11 233* 9 580	14 222* 13 694	16 288* 16 288*				6 770* 2.60 6 770* 2.60											
2 m	4 920* 9.10 3 593 9.10	5 457* 3 659	7 008 4 434	8 676 5 466	10 416* 8 911	12 638* 9 093	16 517* 12 784	7 144* 7 144*				4 879* 2.81 4 879* 2.81											
1 m	5 359* 9.05 3 554 9.05	5 660* 3 583	6 876 4 313	8 476 5 287	10 838 6 950	13 722* 8 707	17 982* 12 216	8 948* 8 948*				4 332* 2.64 4 332* 2.64											
0 m	6 772 8.88 3 598 8.88	6 770 4 217 8 319 5 146										10 611 6 466	14 386* 8 446	18 985* 11 912	8 682* 8 682*	8 652* 2.38	8 652* 2.38						
-1 m	6 019 8.60 3 798 8.60	6 700 4 153 8 212 5 051										10 467 6 329	14 197 8 299	18 328* 11 782	11 057* 11 057*	7 849* 7 849*	7 833* 1.99	8 554* 1.94					
-2 m	6 467 8.18 4 036 8.18	6 677 4 132 8 162 5 026										10 399 6 270	14 130 8 242	17 915* 11 783	13 881* 13 881*	10 585* 10 546*	1.99	8 668* 1.40					
-3 m	7 230 7.60 4 469 7.60	8 176 5 017										10 406 6 276	13 832* 8 262	16 828* 11 830	17 246* 17 246*	13 455* 13 432*	1.99	12 260* 1.40					
-4 m	8 580 6.83 5 279 6.83											10 238* 6 352 12 404* 8 359				15 158* 11 980	18 932* 18 932*	16 732* 16 703*	1.99	15 145* 1.40			
-5 m	8 764* 5.78 6 887 5.78															10 387* 8 549				12 878* 12 233	15 547* 15 547*	18 935* 2.16	18 935* 2.16

SH300-5		SHOE : 600 (mm)G BUCKET : SAE/PCSA 1.30 (m³)		ARM LENGTH - 2.66 (m) MAXIMUM REACH - 8.66 (m)		BOOM : 6.15 (m)							
Bucket Hook Height	Max. Radius	Radius of Load											
		8 m	7 m	6 m	5 m	4 m	3 m	2 m	Min. Radius				
7 m	5 466* 6.99 5 466* 6.99											7 309* 6.26 7 309* 6.26	
6 m	5 451* 7.62 5 157 7.62	7 428* 6 005										7 785* 7 785*	7 789* 5.99 7 789* 5.99
5 m	5 549* 8.08 4 571 8.08	5 957* 4 658	7 789* 5 873	8 378* 7 586								9 011* 5.25 9 011* 5.25	
4 m	5 753* 8.40 4 189 8.40	7 123 4 559	8 259* 5 697	9 164* 7 299	10 572* 9 750	12 976* 12 976*	17 986* 17 986*					15 923*	

Lifting Capacity

- Notes: 1. Ratings are based on SAE J/ISO 10567
 2. Lifting capacity does not exceed 75% of tipping load with the machine on firm, level ground or 87% full hydraulic capacity.
 3. The load point is a hook (not standard equipment) located on the back of the bucket.
 4. *Indicates load limited by hydraulic capacity.
 5. 0m = Ground.

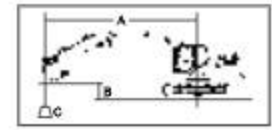

- A: Radius of load
 B: Bucket hook height
 C: Lifting capacity



Unit : kg

SH300-5		SHOE : 800 (mm)G BUCKET : SAE/PCSA 1.30 (m³)		ARM LENGTH = 3.66 (m) MAXIMUM REACH = 9.61 (m)		BOOM : 6.15 (m)		Radius of Load														
Bucket Hook Height	Max. Radius		9 m		8 m		7 m		6 m		5 m		4 m		3 m		2 m		Min. Radius			
	Over Front	Over Side	Over Front	Over Side	Over Front	Over Side	Over Front	Over Side	Over Front	Over Side	Over Front	Over Side	Over Front	Over Side	Over Front	Over Side	Over Front	Over Side	Over Front	Over Side		
8 m	3 579*	7.43	3 579*	7.43															4 089*	7.19	4 089*	7.19
7 m	3 465*	8.16	3 465*	8.16			3 861*	3 861*											5 036*	7.24	5 036*	7.24
6 m	3 428*	8.71	3 428*	8.71			4 935*	4 935*											5 836*	7.04	5 836*	7.04
5 m	3 465*	9.11	3 465*	9.11	3 810*	3 810*	5 746*	4 892	6 598*	6 167									6 808*	6.54	6 808*	6.54
4 m	3 537*	9.39	3 537*	9.39	4 755*	3 867	6 616*	4 765	7 295*	5 972	7 926*	7 695							8 282*	5.66	8 282*	5.66
3 m	3 679*	9.56	3 387	9.56	5 526*	3 774	7 248	4 620	7 927*	5 753	8 882*	7 360	10 389*	9 825	12 862*	12 862*	17 858*	17 858*	7 845*	2.20	7 845*	2.20
2 m	3 887*	9.61	3 279	9.61	6 850	3 677	7 085	4 472	8 671*	5 533	9 883*	7 027	11 877*	9 294	15 356*	13 160	10 608*	10 808*	4 400*	2.45	4 400*	2.45
1 m	4 180*	9.57	3 240	9.57	8 751	3 585	6 933	4 334	8 569	5 332	10 714*	6 733	13 126*	8 649	17 187*	12 460	8 051*	8 051*	3 494*	2.24	3 494*	2.24
0 m	4 586*	9.41	3 270	9.41	6 669	3 509	6 809	4 218	8 384	5 167	10 717	6 501	13 972*	8 528	17 513*	12 034	8 681*	8 681*	4 818*	1.99	5 491*	1.99
-1 m	5 158*	9.14	3 379	9.14	6 615	3 469	6 714	4 134	8 249	5 047	10 532	6 341	14 301	8 327	17 695*	11 816	10 340*	10 340*	7 015*	1.99	7 033*	1.99
-2 m	5 835	8.75	3 588	8.75			6 664	4 088	8 171	4 976	10 428	6 250	14 181	8 227	18 153*	11 737	12 575*	12 575*	8 279*	1.99	8 283*	1.40
-3 m	6 416	8.22	3 943	8.22			6 688	4 092	8 152	4 960	10 400	6 225	13 887*	8 210	17 340*	11 759	15 348*	15 348*	11 747*	1.99	10 561*	1.40
-4 m	7 392	7.51	4 538	7.51					8 204	5 006	10 449	6 268	12 934*	8 271	16 972*	11 670	18 833*	18 833*	14 560*	1.99	13 085*	1.40
-5 m	8 135*	6.57	5 614	6.57							9 246*	6 394	11 327*	8 417	13 898*	12 077	17 432*	17 432*	17 926*	1.99	16 272*	1.50
-6 m	8 063*	5.28	6 002	5.28									8 637*	6 637*	13 752*	10 752*	13 248*	13 248*		1.99	13 771*	2.82

SH300-5		SHOE : 800 (mm)G BUCKET : SAE/PCSA 1.10 (m³)		ARM LENGTH = 3.18 (m) MAXIMUM REACH = 9.10 (m)		BOOM : 6.15 (m)		Radius of Load														
Bucket Hook Height	Max. Radius		9 m		8 m		7 m		6 m		5 m		4 m		3 m		2 m		Min. Radius			
	Over Front	Over Side	Over Front	Over Side	Over Front	Over Side	Over Front	Over Side	Over Front	Over Side	Over Front	Over Side	Over Front	Over Side	Over Front	Over Side	Over Front	Over Side	Over Front	Over Side		
8 m	4 936*	6.75	4 936*	6.75															4 406*	6.72	4 406*	6.72
7 m	4 211*	7.54	4 211*	7.54				5 463*	5 463*										5 809*	6.77	5 809*	6.77
6 m	4 191*	8.13	4 191*	8.13			4 617*	4 617*	6 547*	6 267									6 982*	6.54	6 982*	6.54
5 m	4 252*	8.56	4 252*	8.56			5 968*	4 864	7 288*	6 115	7 758*	7 758*							7 783*	5.95	7 783*	5.95
4 m	4 385*	8.86	3 975	8.86			7 154*	4 751	7 816*	6 932	8 584*	7 829	9 741*	9 741*					10 337*	4.62	10 337*	4.62
3 m	4 607*	9.04	3 761	9.04	4 786*	3 788	7 238	4 620	8 410*	6 729	9 612*	7 293	11 233*	9 677	14 222*	13 769	16 268*	16 268*	6 770*	2.60	6 770*	2.60
2 m	4 920*	9.10	3 639	9.10	5 457*	3 705	7 092	4 487	8 775	5 528	10 418*	6 988	12 638*	9 190	16 517*	12 918	7 144*	7 144*	4 879*	2.61	4 879*	2.61
1 m	5 359*	9.05	3 600	9.05	6 660*	3 630	6 959	4 367	8 676	5 360	10 960	6 727	13 722*	8 804	17 882*	12 361	6 948*	6 948*	4 332*	2.64	4 332*	2.64
0 m	5 844	8.88	3 645	8.88			6 853	4 270	8 418	5 209	10 736	6 531	14 366*	8 544	16 985*	12 047	8 882*	8 882*	6 852*	2.38	6 852*	2.38
-1 m	6 094	8.60	3 787	8.60			6 783	4 206	8 312	5 113	10 691	6 405	14 363	8 396	18 328*	11 917	11 057*	11 057*	7 848*	1.99	8 554*	1.94
-2 m	6 547	8.18	4 068	8.18			6 780	4 195	8 262	5 068	10 623	6 346	14 295	8 339	17 915*	11 896	13 881*	13 881*	10 566*	1.99	9 658*	1.40
-3 m	7 319	7.60	4 525	7.60					8 274	5 080	10 530	6 352	13 632*	8 360	16 828*	11 965	17 248*	17 248*	13 455*	1.99	12 260*	1.40
-4 m	8 059*	6.83	5 344	6.83							10 298*	6 428	12 404*	8 456	16 159*	12 116	18 932*	18 932*	16 732*	1.99	15 145*	1.40
-5 m	8 764*	5.78	6 967	5.78									10 387*	8 647	12 678*	12 968	15 547*	15 547*		1.99	18 935*	2.16

SH300-5		SHOE : 800 (mm)G BUCKET : SAE/PCSA 1.30 (m³)		ARM LENGTH = 2.85 (m) MAXIMUM REACH = 8.66 (m)		BOOM : 6.15 (m)		Radius of Load														
Bucket Hook Height	Max. Radius		8 m		7 m		6 m		5 m		4 m		3 m		2 m		Min. Radius					
	Over Front	Over Side	Over Front	Over Side	Over Front	Over Side	Over Front	Over Side	Over Front	Over Side	Over Front	Over Side	Over Front	Over Side	Over Front	Over Side	Over Front	Over Side				
7 m	5 466*	6.99	5 466*	6.99															7 309*	6.26	7 309*	6.26
6 m	5 451*	7.62	5 272	7.62			7 428*	6 133	7 785*	7 785*									7 789*	5.99	7 789*	5.99
5 m	5 549*	8.08	4 679	8.08	5 957*	4 767	7 789*	6 001	8 378*	7 743									9 011*	5.25	9 011*	5.25
4 m	5 763*	8.40	4 282	8.40	7 294	4 688	8 269*	6 625	9 184*	7 465	10 572*	9 960	12 978*	12 978*	17 986*	17 986*			15 923*	2.63	15 923*	2.63
3 m	6 072*	8.58	4 046	8.58	7 163	4 549	8 798*	6 631	10 029*	7 147	11 998*	9 434	15 502*	13 293					8 984*	3.19	8 984*	3.19
2 m	6 212	8.65	3 910	8.65	7 031	4 429	8 684	5 443	10 838*	6 856	13 242*	8 977	17 478*	12 523					8 903*	3.37	8 903*	3.37
1 m	6 190	8.60	3 873	8.60	6 916	4 323	8 504	5 282	10 845	6 623	14 108*	8 641	15 127*	12 093					6 102*	3.22	6 102*	3.22
0 m	6 322	8.42	3 936	8.42	6 829	4 245	8 370	5 163	10 666	6 456	14 417	8 436	16 031*	11 910	7 798*	7 798*			7 955*	2.85	7 955*	2.85
-1 m	6 839	8.12	4 118	8.12	6 766	4 205	8 291	5 092	10 549	6 365	14 301	8 339	18 113*	11 863	11 392*	11 392*			10 027*	2.38	10 027*	2.38
-2 m	7 218	7.67	4 464	7.67			8 273	5 076	10 520	6 340	13 982*	8 328	17 231*	11 903	15 196*	15 196*	11 804*	11 804*	11 786*	1.99	12 128*	1.65
-3 m	8 233	7.06	5 072	7.06			8 331	5 128	10 570	6 383	13 037*	8 391	15 865*	12 020	19 540*	19 540*	15 474*	15 474*	15 452*	1.99	14 485*	1.55
-4 m	8 965*	6.22	6 196	6.22					9 401*	6 513	11 472*	8 537	13 860*	12 225	16 805*	16 805*	19 699*	19 699*	19 685*	1.99	19 685*	1.97
-5 m	8 768*	5.04	6 713	5.04							8 644*	6 609	10 857*	10 857*					12 878*	3.02	12 878*	3.02

Principle Specifications

		SH300-5
		STD Specifications
Base	Boom length	6.15 m
	Arm length	3.18 m
	Bucket capacity (ISO heaped)	1.10 m ³
	Std. operating weight	29,100 kg
Engine	Make & model	ISUZU AH-6HK1X
	Rated output	154 kW/1 800 min ⁻¹
Hydraulic System	Displacement	7 790 ml(cc)
	Main pump	2 variable displacement axial piston pumps with regulating system
	Max pressure	34.3 Mpa
	(with auto power boost)	37.3 Mpa
	Travel motor	Variable displacement axial piston motor
	Parking brake type	Mechanical disc brake
	Swing motor	Fixed displacement axial piston motor
	Travel speed	5.6/3.2 km/h
	Traction force	233.2 kN
	Grade ability	70% <35°>
Performance	Ground pressure	56 kPa
	Swing speed	10.2 min ⁻¹
	Bucket	175 kN
	/with power boost	190 kN
	Arm	122 kN
/with power boost	132 kN	
Others	Fuel tank	450 liters
	Hydraulic fluid tank	147 liters

Standard equipment

[Hydraulic system]

- SIH-S hydraulic system
- Operation mode (SP, H and A mode)
- Auto/one-touch idling
- Automatic 2-speed travel
- Automatic power boost
- Arm/boom/bucket reactivation circuit
- Automatic swing parking system
- High-performance return filter

[Cab/interior equipment]

- Tilting console
- Open air introducing pressurized full-automatic air conditioner
- Defroster
- Hot & cool box
- Water-repelling operator's seat
- Seat suspension
- Rise-up wiper (with intermittent operation function)
- Cup holder
- AM/FM radio (with muting function)
- Clock
- Magazine rack
- Accessory case
- Floor mat
- Armrest & headrest
- Ashtray & cigar lighter
- Room light (Auto-OFF function)
- Coat hook

[Safety equipment]

- Rearview mirror (left/right)
- Emergency escape tool
- Winding seat belt
- Gate lock lever
- Travel alarm (with on and off switch)
- Anti-theft alarm system
- Engine room firewall
- Fan guard
- Engine emergency stop switch

[Others]

- EMS
- Long-life hydraulic oil
- Two lights (main unit and left of arm)
- Fuel filter (with water separator)
- Fuel prefilter (with water separator)
- Double-element air cleaner
- Grease-enclosed track link
- Bucket rattling control mechanism
- Large tool box
- A set of tools

Accessories (option)

■ Cab-top light



■ Rain reflector



■ 12V power (DC-DC converter)



■ Head guard (FOPS level 2)



■ Polycarbonate with sunshade roof top window



■ Air suspension (KAB 855)



■ Rear view camera and monitor



Working Range

		SH300-5		
		2.65 m	3.18 m	3.66 m
Arm length		2.65 m	3.18 m	3.66 m
Boom length		6.15 m		
A Max digging radius		10 220 mm	10 670 mm	11 160 mm
B Max digging depth		6 570 mm	7 100 mm	7 580 mm
C Max digging height		9 930 mm	10 060 mm	10 390 mm
D Max dumping height		6 940 mm	7 090 mm	7 390 mm
E Max vertical wall cut depth		5 760 mm	6 120 mm	6 720 mm
F Min. front swing radius		4 000 mm	3 920 mm	4 000 mm
G Rear end swing radius		3 160 mm		

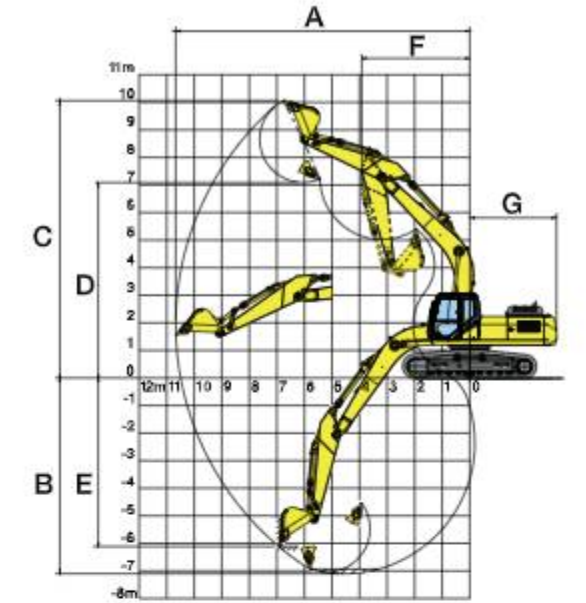

Dimensions

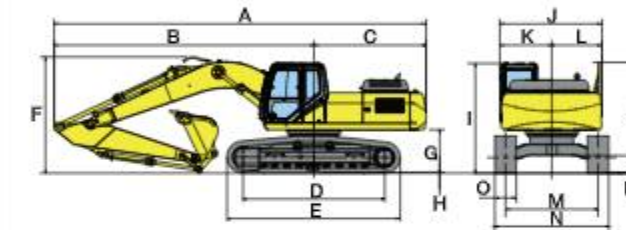

		SH300-5		
		2.65 m	3.18 m	3.66 m
Model		SH300-5		
Arm length		2.65 m	3.18 m	3.66 m
A Overall length		10 480 mm	10 450 mm	10 470 mm
B Length from center of machine (to arm top)		7 330 mm	7 300 mm	7 320 mm
C Upper structure rear end radius		3 150 mm	3 150 mm	3 150 mm
D Center to center of wheels		3 980 mm	3 980 mm	3 980 mm
E Overall track length		4 850 mm	4 850 mm	4 850 mm
F Overall height		3 340 mm	3 260 mm	3 460 mm
G Clearance height under upper structure		1 190 mm	1 190 mm	1 190 mm
H Shoe lug height		26 mm	26 mm	26 mm
I Cab height		3 080 mm	3 080 mm	3 080 mm
J Upper structure overall width		2 870 mm	2 870 mm	2 870 mm
K Width from center of machine (left side)		1 460 mm	1 460 mm	1 460 mm
L Width from center of machine (right side)		1 410 mm	1 410 mm	1 410 mm
M Track gauge		2 600 mm	2 600 mm	2 600 mm
N Overall width		3 200 mm	3 200 mm	3 200 mm
O Std. Shoe width		600 mm	600 mm	600 mm
P Minimum ground clearance		470 mm	470 mm	470 mm
Q Handrail height		3 110 mm	3 110 mm	3 110 mm