



20. General Information	35
20.1 Warning!.....	35
21. Technical details	35
21.1 Electromagnetic compatibility (EMC).....	35
21.2 Electrical details.....	35
22. Feedback potentiometer installation and adjustment	36
22.1 Pre-conditions required for adjustment of the feedback potentiometer.....	36
22.2 Required parts.....	37
23. Installation REpos	39
23.1 Required parts.....	39
24. Wiring diagram REact 15E	43
25. Wiring diagram REact 30/ 60/ 100	44
26. Wiring diagram REact 60E-170 / ...100E-090	45
27. Wiring diagram REact 30-DC/ 60-DC/ 100-DC	46
28. Wiring diagram REact 30-DC/ 60-DC/ 100-DC with int. power supply	47
29. Electrical connections	48

30. Operation	49
30.1 Operation	50
30.2 Automatic mode operation	50
30.3 Manual mode operation	50
30.4 Menu navigation	50
30.5 Editing parameter	50
31. General menu map	51
31.1 Diagnostic menu map	52
31.2 Diagnostic data	53
31.3 Configuration menu map	54
31.4 Configuration parameter	55
31.5 General operation commands menu map	56
32. Commands	57
32.1 Auto Initialization Procedure	57
32.2 Auto initialization procedure menu map	58
32.3 Input calibration procedure menu map	59
33. Setpoint vs Effective Actuator Direction (SpRv)	60
34. Split Range Mode (SpIM)	61
35. Setpoint vs Valve Stroke Characteristic (SpLn)	62
36. Close Tight Function (CITe)	63
37. Minimum Travel Time Out (MnTT)	64

20. General Information

20.1 Warning!

Before beginning the installation or operation of electrical equipment, please read the following print "**Warnings of hazards...**"



All work on electrical systems or production equipment must be carried out by authorized personnel. Electrical installation (cables) must be carried out according to the regulations applicable in the respective countries (**Germany VDE 100**). Measurement and signal cable must be kept separate from power cables to avoid EMC effects.

If a riskless operation is no longer possible, the equipment must be taken out of service and made safe against accidental operation.



The electronics in the positioner contains components that are susceptible to electric static. Electric static discharges must be avoided using suitable measures.

21. Technical details

21.1 Electromagnetic compatibility (EMC)

Regarding **EMC** the positioner complies with the following regulations and directives:

Directive 2014/35/EU and EN61010-1:2011-07 for electrical equipment

Directive 2004/108/EEC for electromagnetic compatibility.

Regulations for HF Emission: EN61000-6-4:2007 for industrial environment

Regulations for HF Immunity to interference: EN61000-6-2:2005 for industrial equipment

21.2 Electrical details

data electrical	
Display	128*64 dot graphic display
Input	current 0(4)-20mA/ R _i ca. 10Ω /voltage 0(2)-10V R _i ca. 100kΩ
control output AC version	solid state relays (SSR) max 250V / 50/60Hz 2.5A
control output DC version	high side transistor 24 V dc 100mA max
feedback potentiometer	conductive plastic 1kΩ or angle sensor (U _v 5V)
feedback signal optional	current 0(4)-20mA/ R _L ca. 500Ω /voltage 0(2)-10V galvanic isolated
supply	115/230V 50/60Hz or 24V 50/60Hz or 24V dc
power consumption	ca. 3VA
data mechanical	
electrical connection	plug connector supply AWG 24-12 / signal AWG 26-16
screw supply plug	M3 / 0.34Nm
screw signal plug	M2 / 0.34Nm

22. Feedback potentiometer installation and adjustment

22.1 Pre-conditions required for adjustment of the feedback potentiometer

The actuator must be mounted and adjusted on the control valve

Fasten the actuator to the valve body using the pillars. **(2)**

Connect the valve plug / spindle with the actuator spindle **(1)**

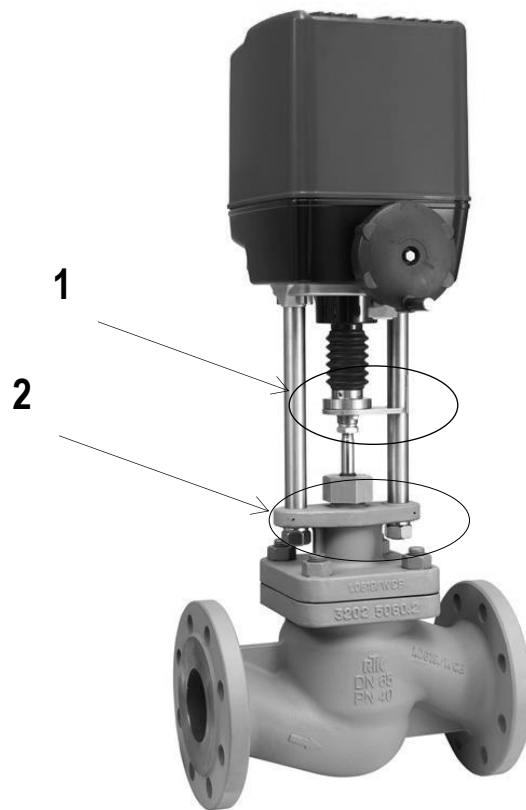

Set the limit switches to the real stroke of the control valve. i.e. It must be certain that the actuator switches off when the end position has been reached. **(3)**

pls note cut off modes!!
(limit or torque switch off)

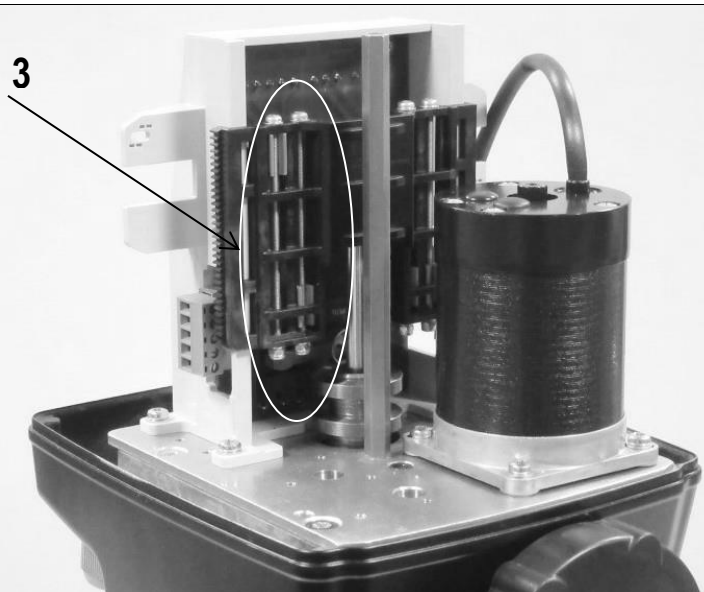



Pictures are **exemplary** und apply for all actuators Type **REact**

22.2 Required parts

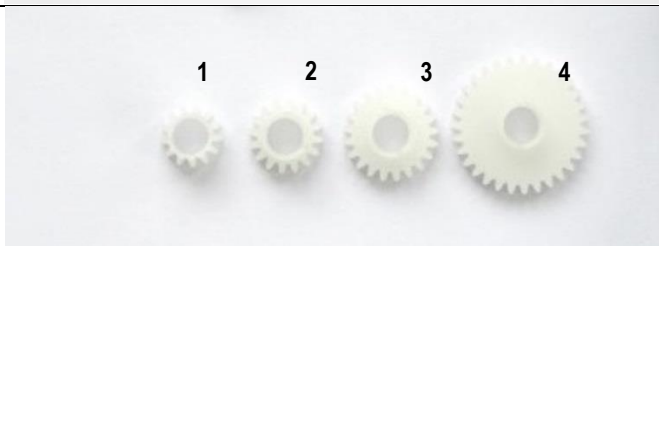
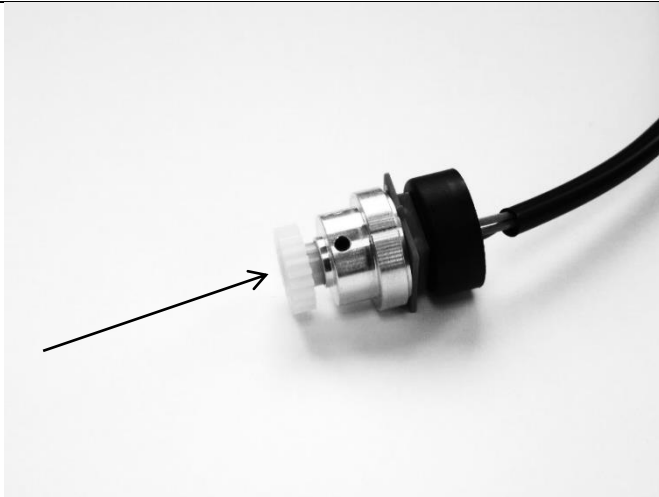
Actuator Type REact

<p> 1 x potentiometer-group 1 x potentiometer-pinions 1 x leg spring 1 x screw M3x 12 TX10 1 x nut M3 SW 5.5 2 x washer 1 x distance bush </p>	
<p> Select potentiometer pinion depending on the real valve stroke. </p> <p> Up to 50mm real valve stroke... Nr.1 stroke 0-24mm (dk 10.5mm) Nr.2 stroke 25-29mm (dk 12.6mm) Nr.3 stroke 30-36mm (dk 16.1mm) Nr.4 stroke 37-54mm (dk 23.1mm) </p> <p> From > 50mm real valve stroke (Actuator with adaption spindle) Nr.4 stroke 37-54mm (dk 23.1mm) </p>	
<p> Push the selected pinion on the potentiometer shaft. </p>	

Actuator Type REact

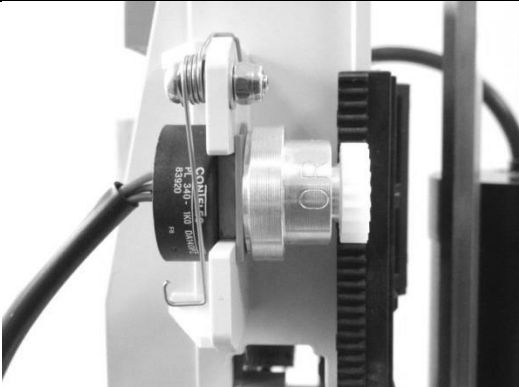
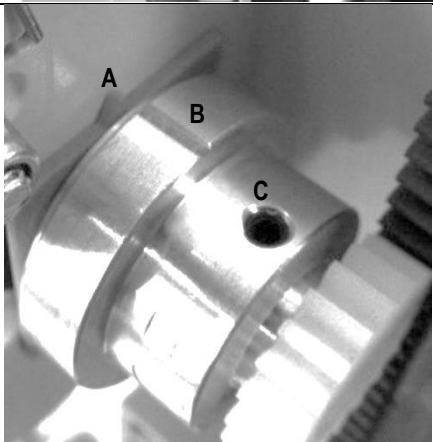
<p>Drive the actuator in 0% stroke position as shown. → Actuator must be switch off in 0% position via limit / torque switch.</p>	
<p>Install the leg spring as shown</p>	
<p>Install the potentiometer group as shown → The leg spring must keep the potentiometer pinion form closed with the teeth of the slide!</p>	
<p>Rotate adjusting ring until the marking (A) and (B) are aligned as shown. Fasten the pinion securely in place (C) by using an Allen key (size 1.5).</p>	

Actuator Type REact

Check the resistance in 0% position.
The measured value between the grey and red
wire should be approx. $100\Omega \pm 20\Omega$

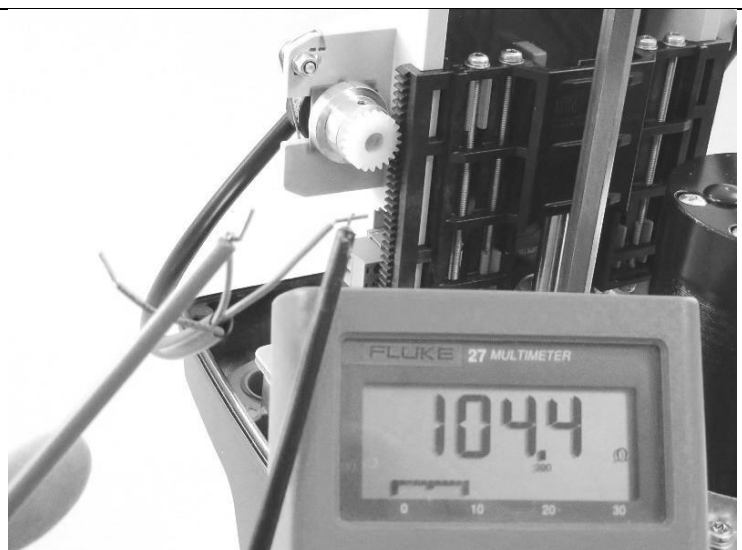

23. Installation REpos



23.1 Required parts

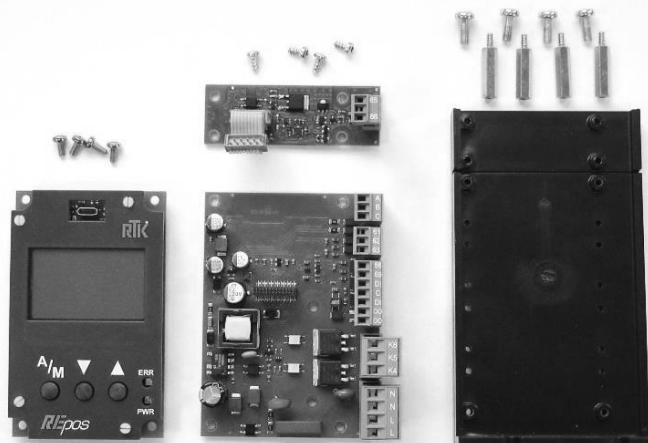

1x mounting bracket
4x screw M4 x10 (TX20)
1x power-board
4x distance bolt (5,5x20mm) self-cutting
1x CPU-board (Display)
4x screw M3 x6 (Philips screw)

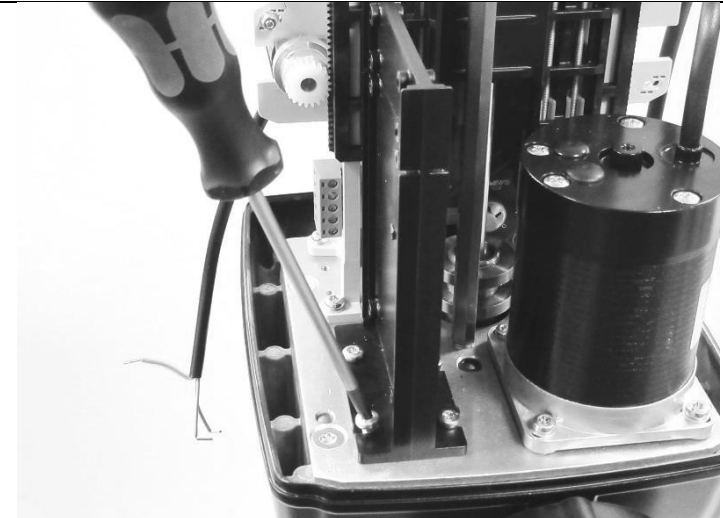
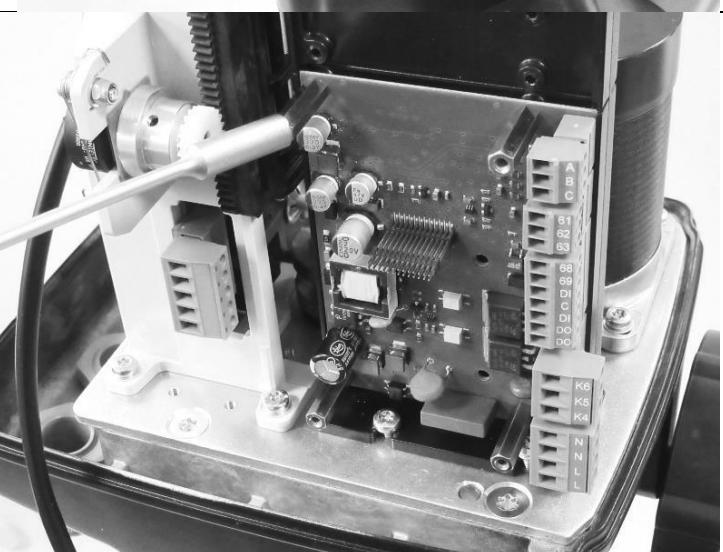
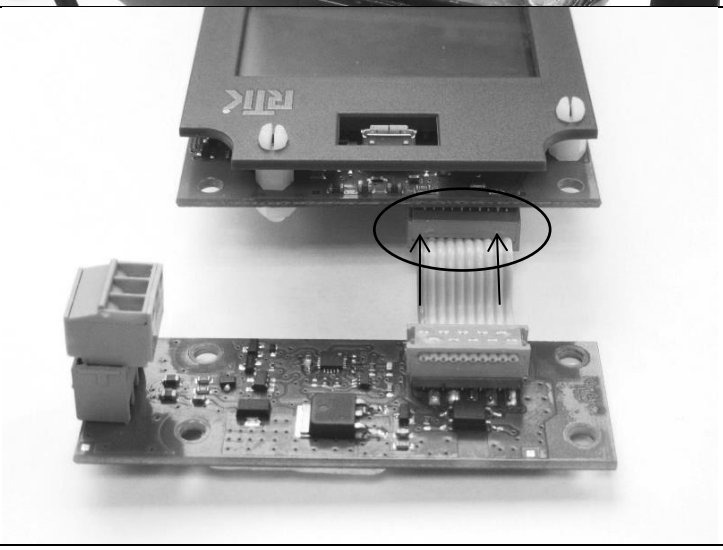
optional
signal feedback -module
4x screw 3x6 self-cutting (TX10)

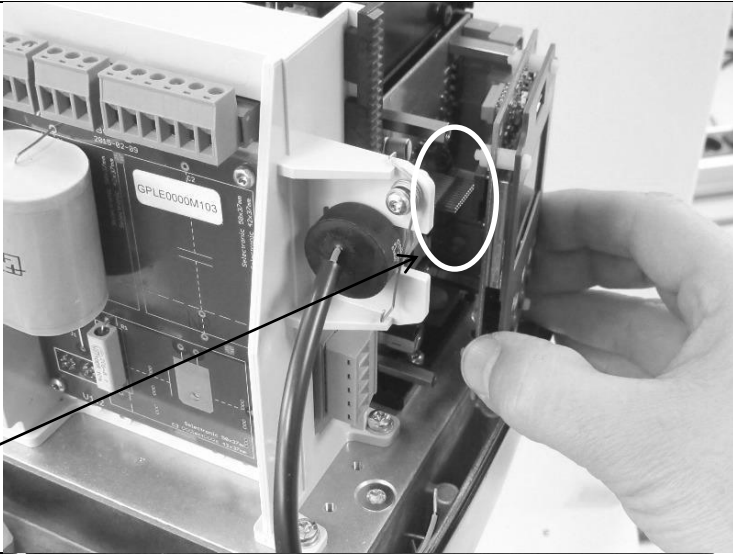
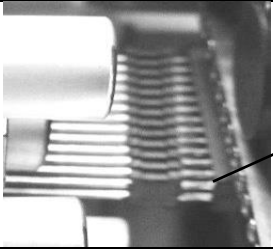
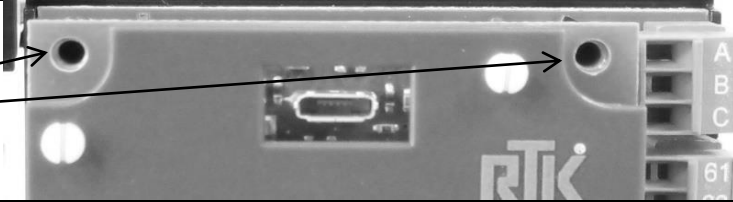
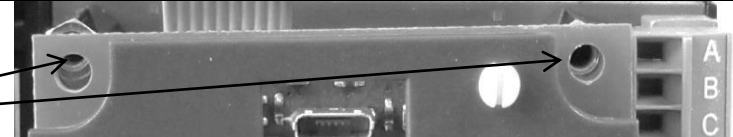

<p>Fasten mounting bracket as shown. 4x screw M4 x 10 (TX20)</p>	
<p>Fix the Power-board 4x distance bolt (5,5x20mm) self-cutting</p>	
<p>optional Connect feedback module with CPU-board as shown.</p>	

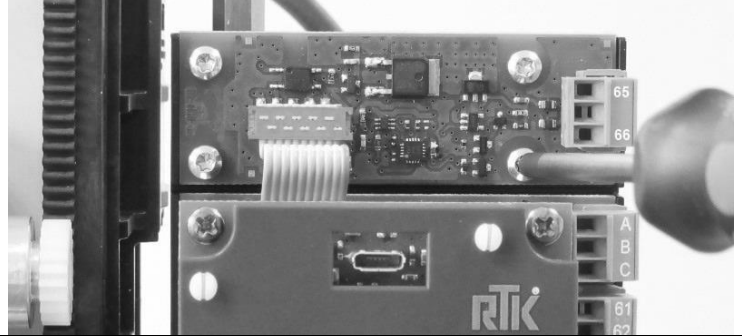
<p>Connect CPU-board with power board</p> <p></p> <p>Pay attention that plug in connector is connected correctly.</p>	
	
<p>Plug and socket connection OK</p>	
<p>Plug and socket connection not OK</p>	
<p>Fasten the CPU-board</p> <p>4x screw M3 x6 (Philips screw)</p>	

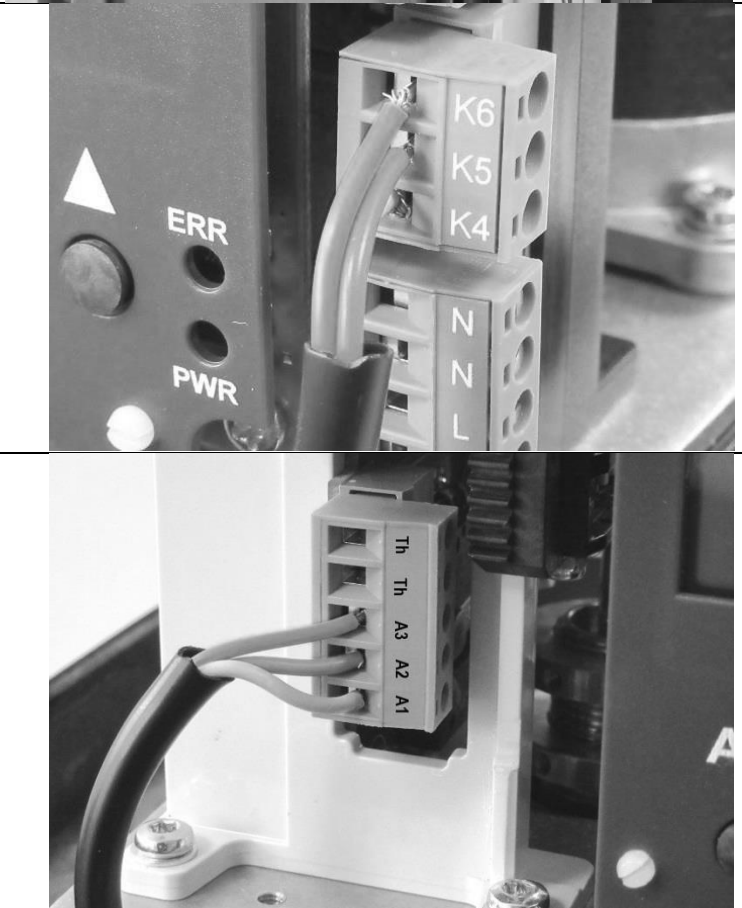
<p>optional Fix feedback module 4x screw 3x6 self-cutting(TX10)</p>	
<p>Connect pre adjusted feedback potentiometer.</p> <p>Yellow wire → terminal 61 Grey wire → terminal 62 Red wire → terminal 63</p>	
<p>Connect positioner output with actuator.</p> <p>Grey wire terminal K4 to terminal A1 Red wire terminal K5 to terminal A2 Yellow wire terminal K6 to terminal A3</p>	

25. Wiring diagram **REact 30/ 60/ 100**

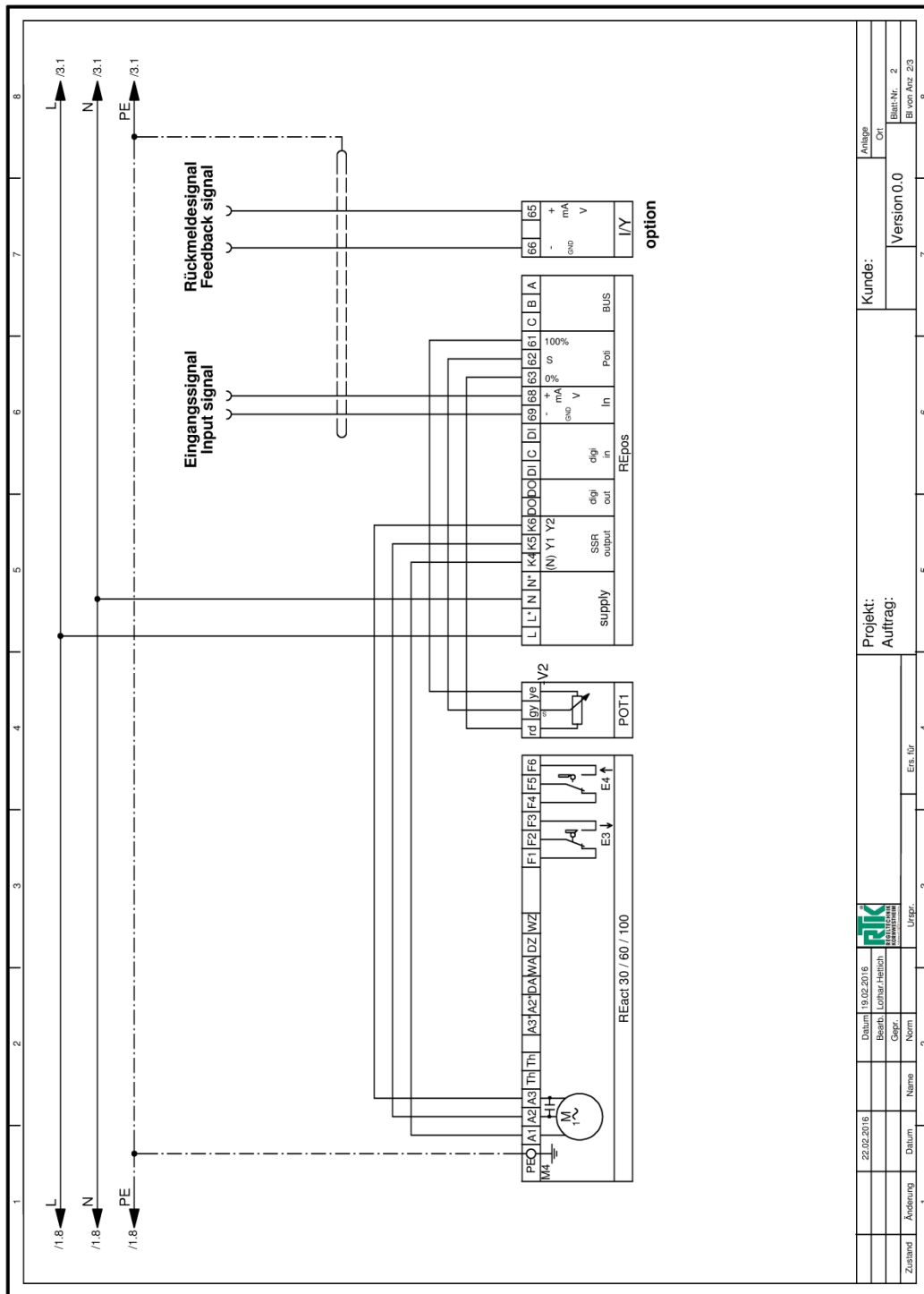

Regeltechnik Kornwestheim GmbH
 Max-Planck-Straße 3
 70806 Kornwestheim
 GERMANY

Telefon +49 7154 1314-0
 Telefax +49 7154 1314-333
 Internet www.rtk.de
 E-Mail: info@rtk.de



Choose the Original
 Choose Success!

REGELTECHNIK
KORNWESTHEIM

A division of CIRCOR International, Inc.

27. Wiring diagram **REact 30-DC/ 60-DC/ 100-DC**

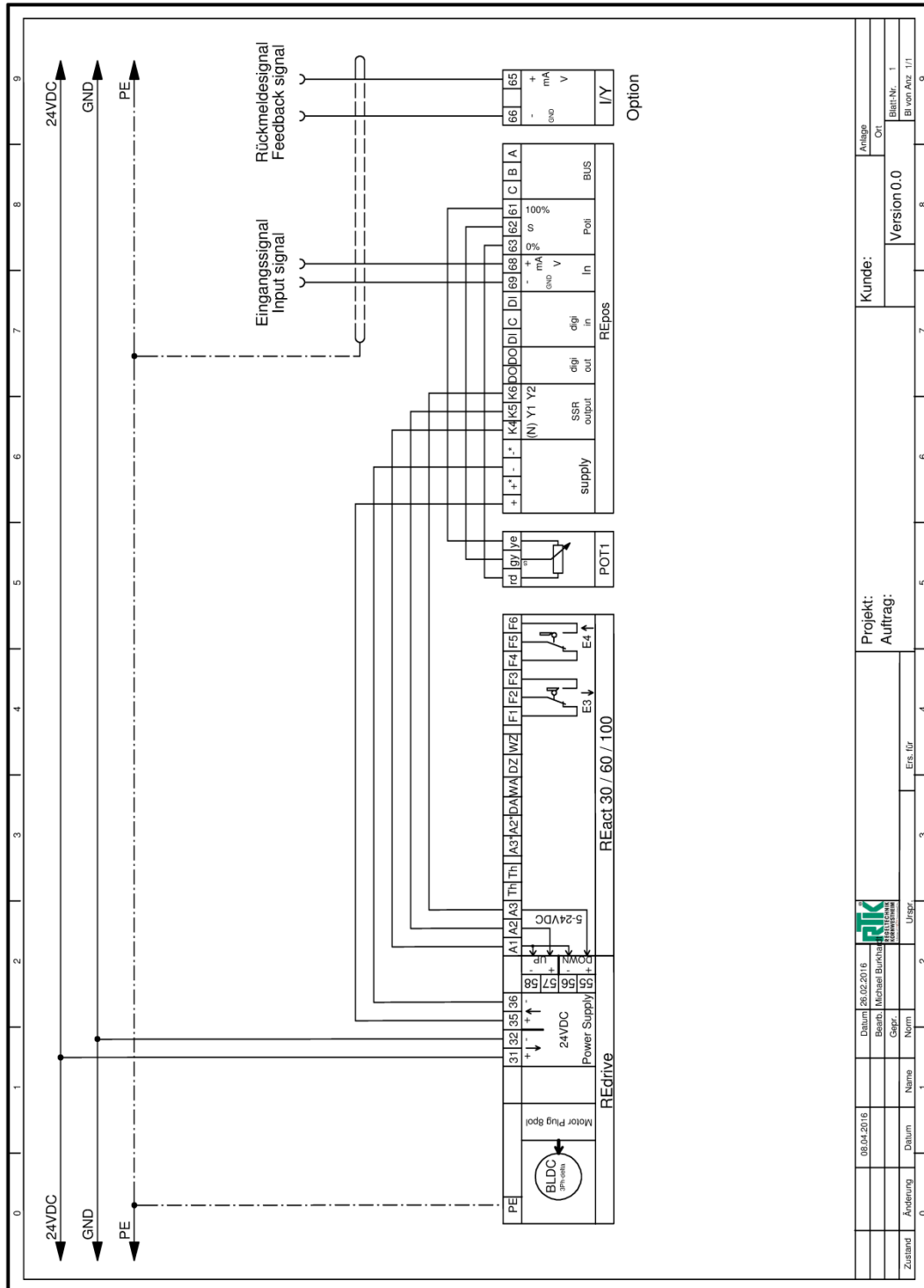

Regeltechnik Kornwestheim GmbH
 Max-Planck-Straße 3
 70806 Kornwestheim
 GERMANY

Telefon +49 7154 1314-0
 Telefax +49 7154 1314-333
 Internet www.rtk.de
 E-Mail: info@rtk.de



Choose the Original
 Choose Success!

**REGELTECHNIK
 KORNWESTHEIM**

A division of CIRCOR International, Inc.

28. Wiring diagram **REact 30-DC/ 60-DC/ 100-DC with int. power supply**

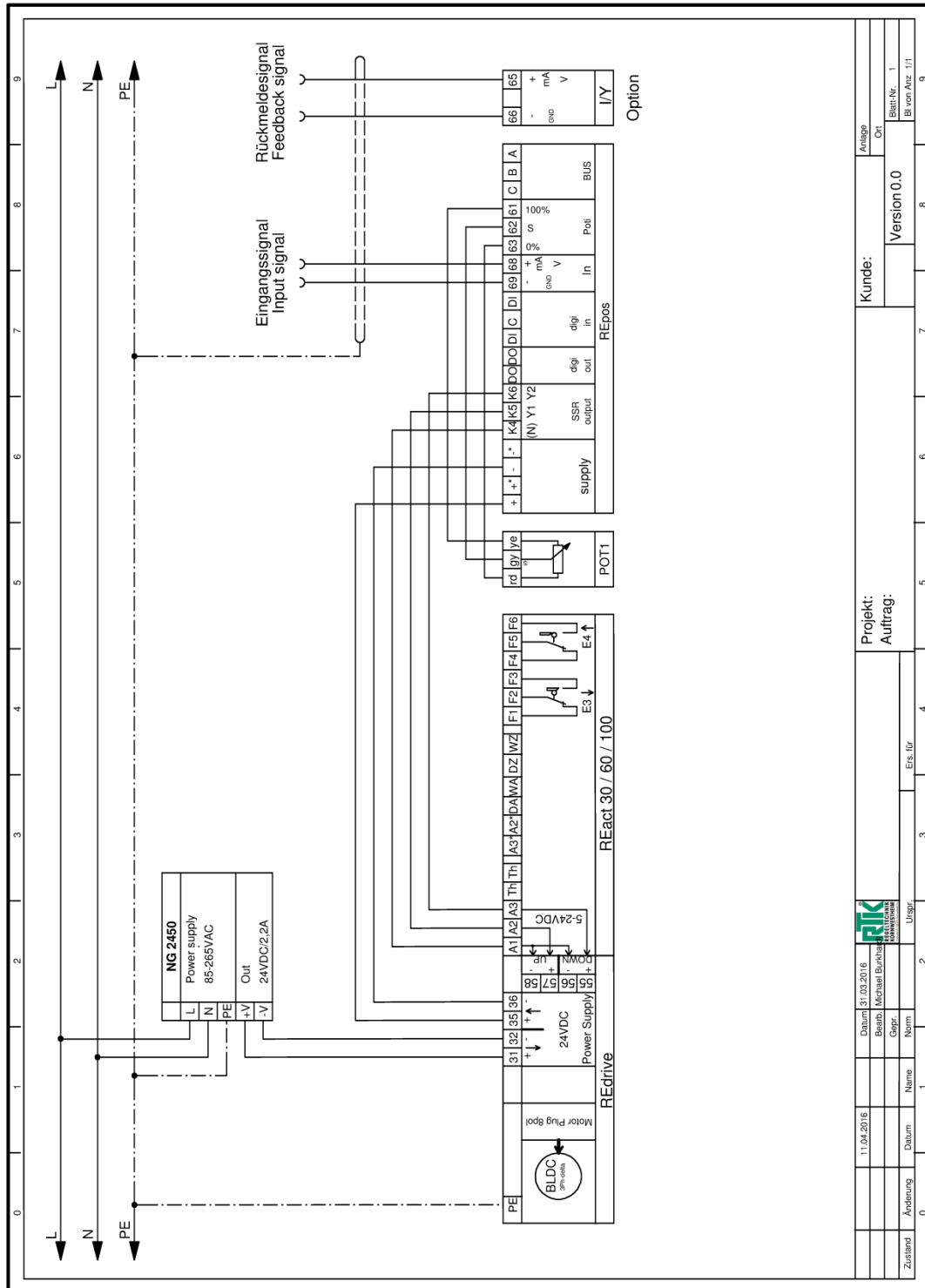

29. Electrical connections

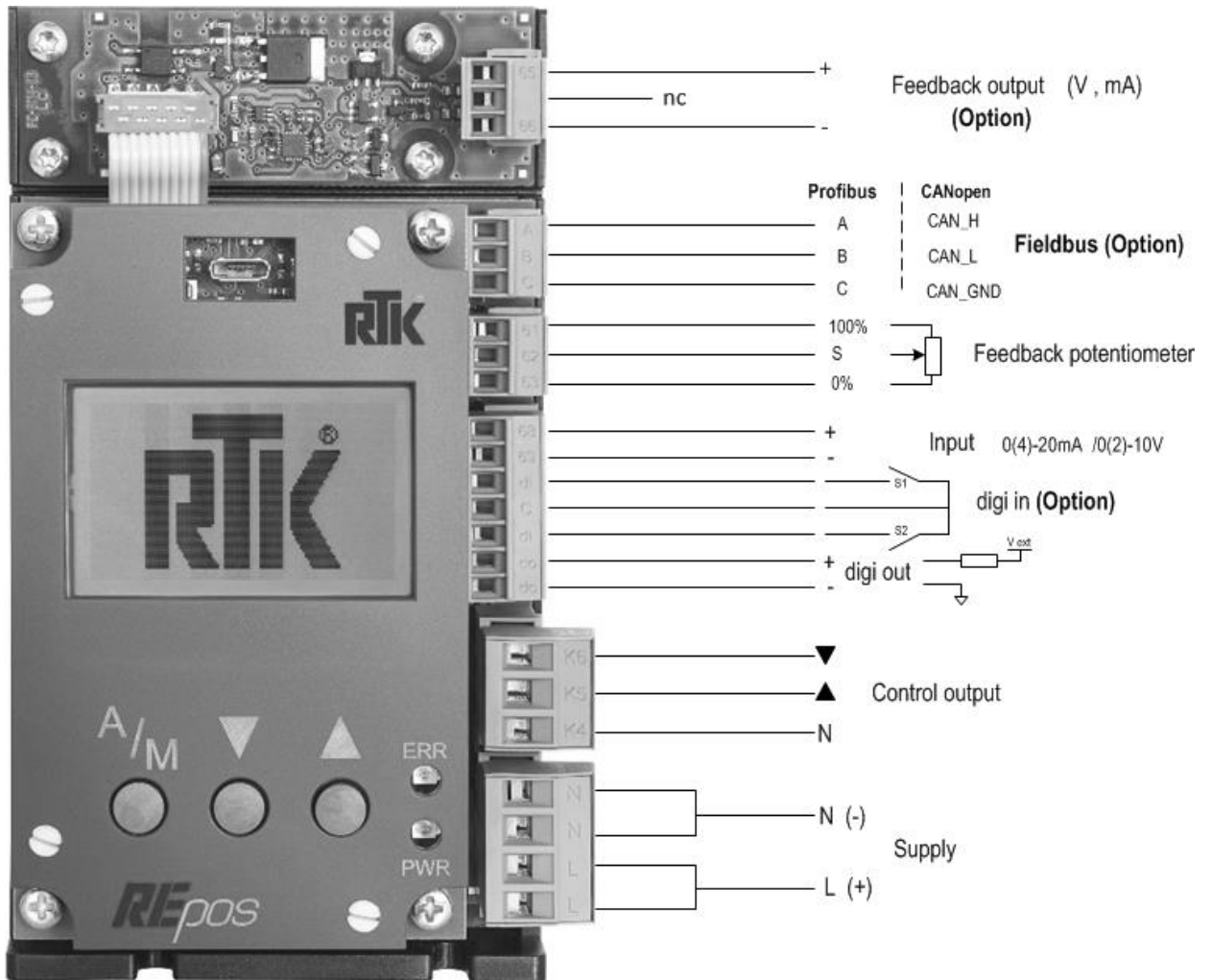

30. Operation

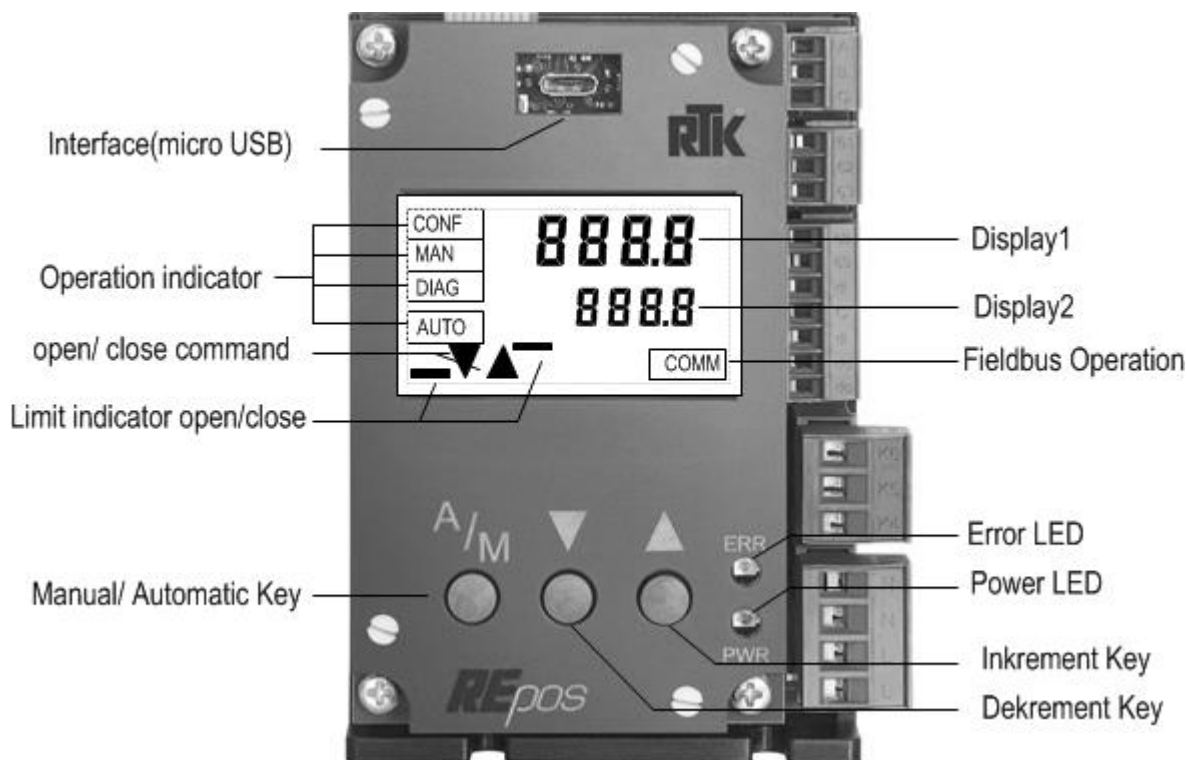



- Display 1** indicates the current position (0-100%) in manual / automatic operation and the parameter name at configuration level.
- Display 2** indicates the in manual / automatic operation the target position (0-100%) and the parameter value at configuration level.
- Decrement Key ▼** serves to navigate through the parameter menu and to decrease the selected parameter values. or to move the actuator in manual mode
- Increment Key ▲** serves to navigate through the parameter menu and to increase the selected parameter values or to move the actuator in manual mode
- Interface(micro USB)** **for RTK internal use only!**
⚠ Improper use can lead to the destruction of the device!

30.1 Operation

The **REpos** is operated by the three key switches.



The **A/M** Key serves to switch over the operating modes and select the menu items.

The decrement key  serves to navigate through the parameter menu, and to decrease the selected parameter value.

The increment key  serves to navigate through the parameter menu and to increase the selected parameter value.



30.2 Automatic mode operation

Key function:

Key		Description
A/M	single press (1s)	switch to manual mode
	long press (>4s)	switch to diagnostic/configuration/command mode
	press	no effect
	press	no effect



30.3 Manual mode operation

Key function

Key	Action	Description
A/M	single press (1s)	switch to automatic mode
	long press (>4s)	switch to diagnostic/configuration/command mode
	press	close output actuated
	press	open output actuated



30.4 Menu navigation

Key function

Key	Action	Description
A/M	press (1s)	menu item selection
	long press (>4s)	exit menu
	press	next menu item
	press	previous menu item

30.5 Editing parameter

Key function

Key	Action	Description
A/M	press (1s)	confirm the value and proceed to next item
	long press (>4s)	exit the menu and discard value change
	press	decrease value / go to next parameter
	press	increase value / go to previous parameter

31. General menu map

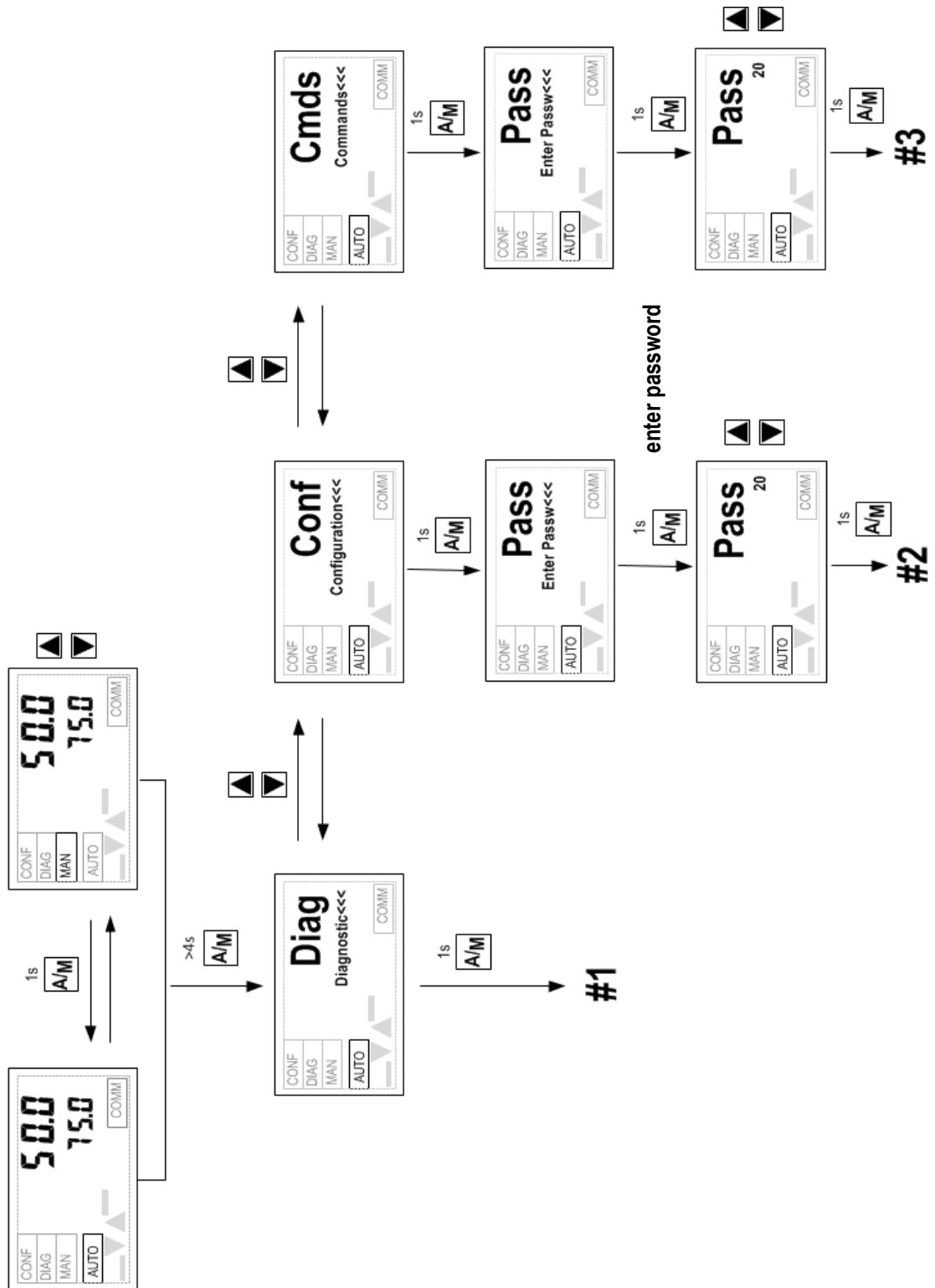

31.1 Diagnostic menu map

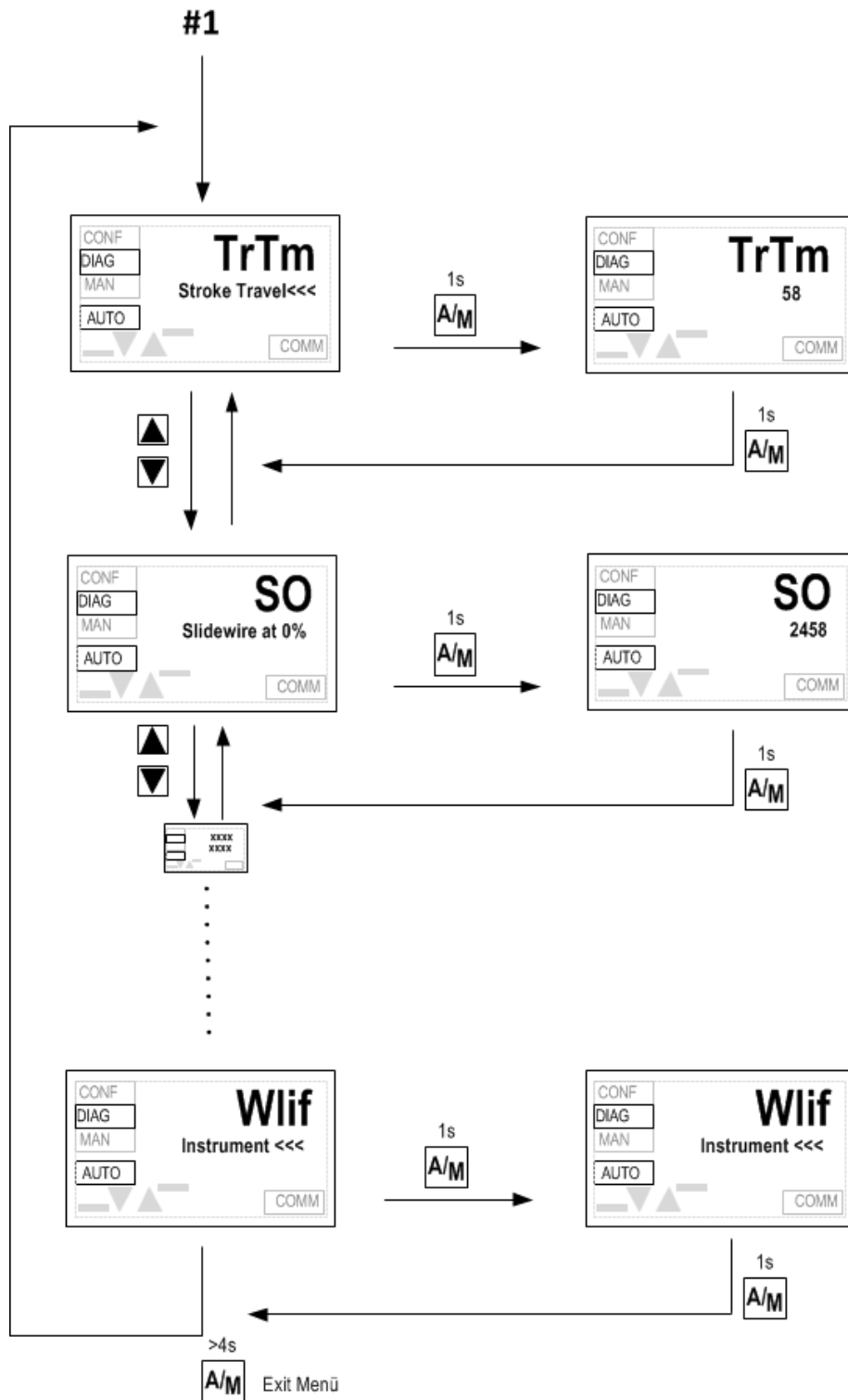



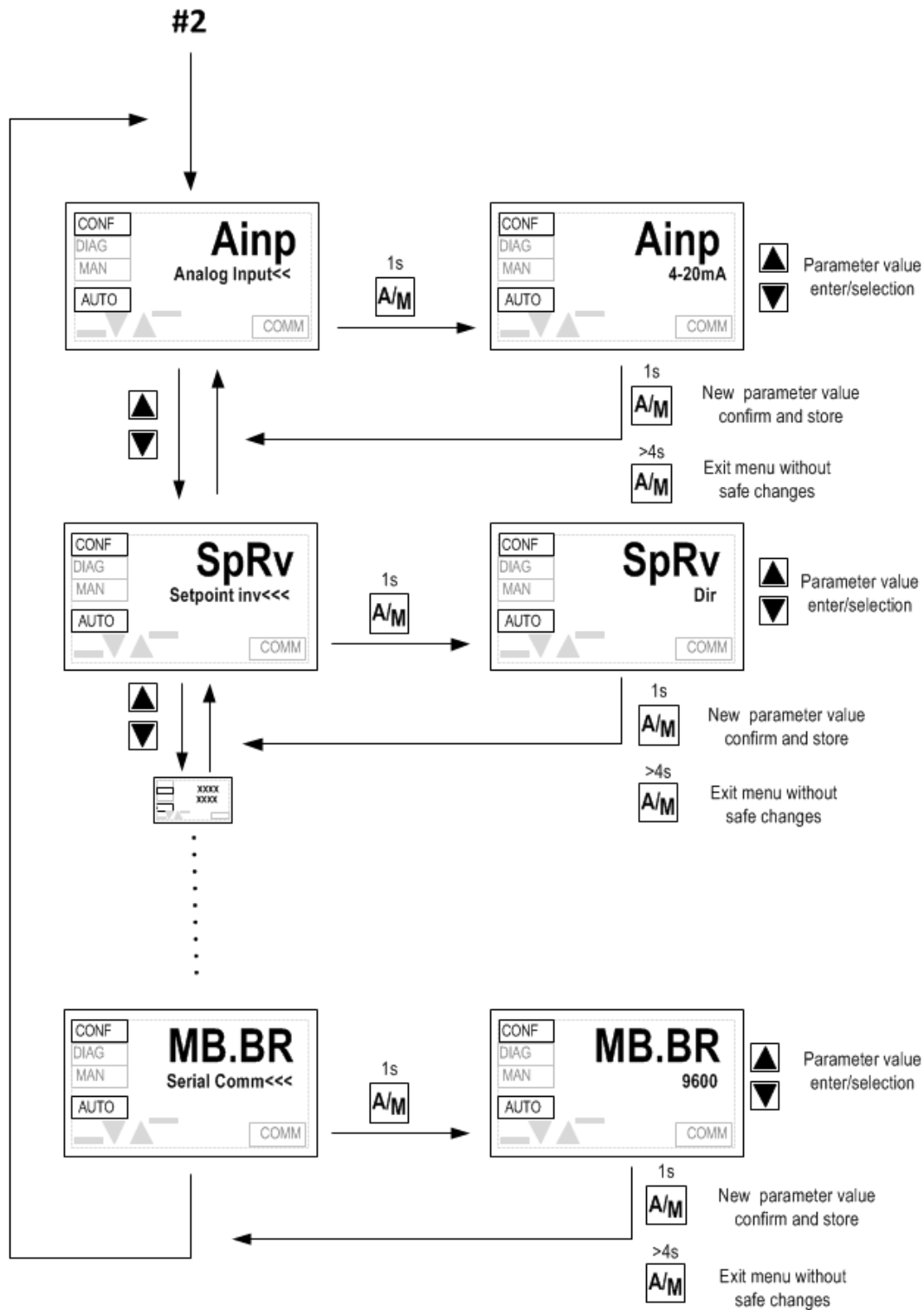

31.2 Diagnostic data

Diagnose data				
#	Display	Description	Range	Function
1	TrTm	Motor travel time	0....9999	Detected motor travel time during Init procedure
2	S0	Potentiometer value at 0%	0....100%	Potentiometer value at 0% stroke
3	S100	Potentiometer value at 100%	0....100%	Potentiometer value at 100% stroke
4	Hyst	Dead band	0.5....5.0%	Detected dead band during Init procedure
5	WHrs	Working hours	0....999k	Working hours total
6	TStr	Strokes	0....999k	Operating commands total
7	Str1	Strokes within 0..25%	0....999k	Operating commands within 0-25% of real stroke
8	Str2	Strokes within 25..50%	0....999k	Operating commands within 25-50% of real stroke
9	Str3	Strokes within 50...75%	0....999k	Operating commands within 50-75% of real stroke.
10	Str4	Strokes within 75...100%	0....999k	Operating commands within 75-100% of real stroke
11	iErr	Input error	0....999k	Total count input signal out of range
12	SErr	Potentiometer error	0....999k	Total error Potentiometer input
13	CErr	Communication error	0....999k	Total error communication
14	Temp	Temperature	-5°C....80°C	Current „on board“ temperature
15	Tmin	min. temperature	-5°C....80°C	min. „on board“ temperature
16	Tmax	max. temperature	-5°C....80°C	max. on board“ temperature
17	HrT1	Hours in temp. range T1	0....999k	Operating hours in range < 0°C
18	HrT2	Hours in temp. range T2	0....999k	Operating hours in range 0°C....30°C
19	HrT3	Hours in temp. range T3	0....999k	Operating hours in range 30°C....50°C
20	HrT4	Hours in temp. range T4	0....999k	Operating hours in range 50°C....70°C
21	HrT5	Hours in temp. range T5	0....999k	Operating hours in range > 70°C
22	Wlif	Instrument life hours	0....999k	Operating hours total non-resettable

31.3 Configuration menu map



31.4 Configuration parameter

Configuration parameter				
#	Display	Description	Parameter Value	Function
1	Ainp	Analog Input	0-20mA / 4-20mA 0-10V / 2-10V	Setpoint Input type current/ voltage
2	SpRv	Setpoint Inversion	Dir (Direct) Rev (Reverse)	Changes the direction of the setpoint e.g. 4mA actuator spindle extended or 4mA actuator retracted  chapter 34
3	Aout	Analog Output Type	0-20mA / 4-20mA 0-10V / 2-10V	Optional Select feedback signal output type
4	Rinv	Feedback signal Inversion	Dir (Direct) Rev (Reverse)	Changes the direction of the feedback signal e.g. 4mA actuator spindle extended or 4mA actuator retracted
5	SpIM	Split range mode	None, High, Low	 chapter 35
6	SpIT	Split range Threshold	20...80%	Split point
7	Safe	Safety Position	Off Open Close	Actuator position in error mode e.g. Input signal fault.....
8	DBnd	Dead band	0.5...5.0%	neutral Zone between operation commands open ->close or close->open
9	MnTT	Minimum Travel Timeout	0.....1000s	Minimum delay to enter in position error  chapter 38
10	CITe	Close Tight Enable	En (Enabled) Dis (Disabled)	Close Tight Function enabling  chapter 37
11	CITB	Close Tight Band	0.5...5.0%	Close Tight value for open /close limits
12	SpLn	Setpoint Linearization Enable	En (Enabled) Dis (Disabled)	Setpoint Linearization with max. 21 Interpolation-points  chapter 36
13	SL0	Interpolation point 0 (0%)	0....100%	Parameters are displayed if SpLn is enabled
..
33	SL20	Interpolation point 20 (100%)	0....100%
34	RM.SP	Remote Setpoint Fieldbus	0....100%	If Fieldbus operation is active, the value of the digital setpoint received is displayed.
35	RSP.H	Remote Setpoint High Limit	0....100%	max. Setpoint value accepted from fieldbus
36	RSP.L	Remote Setpoint Low Limit	0....100%	min Setpoint value accepted from fieldbus
37	PW.GL	Password Global Access	-1999....9999	Password for Config and CMD menu access
38	PW.CF	Password Config Access	-1999....9999	Password for Config menu only
39	FL.cl	Force Local Control	En (Enable) Dis (Disable)	If Enable remote control from fieldbus is inhibited
40	CBus	Fieldbus selection	None CAN open Profibus DP	optional Fieldbus selection (Proper optional hardware required)
41	Addr	Node Address	1....127	Fieldbus Node Address -> Parameter displayed only if fieldbus is active
42	Baud	Baud Rate (Kbit/s)	20,50,100,125,250, 500,1000	Only for CAN open Profibus baud rate auto selected
43	MB.AD	Modbus Address	1...255	Node Address Modbus
44	MB.BR	Serial Com Baud Rate	4800,9600,19200 38400,57600	Baud rate Modbus Communication

31.5 General operation commands menu map

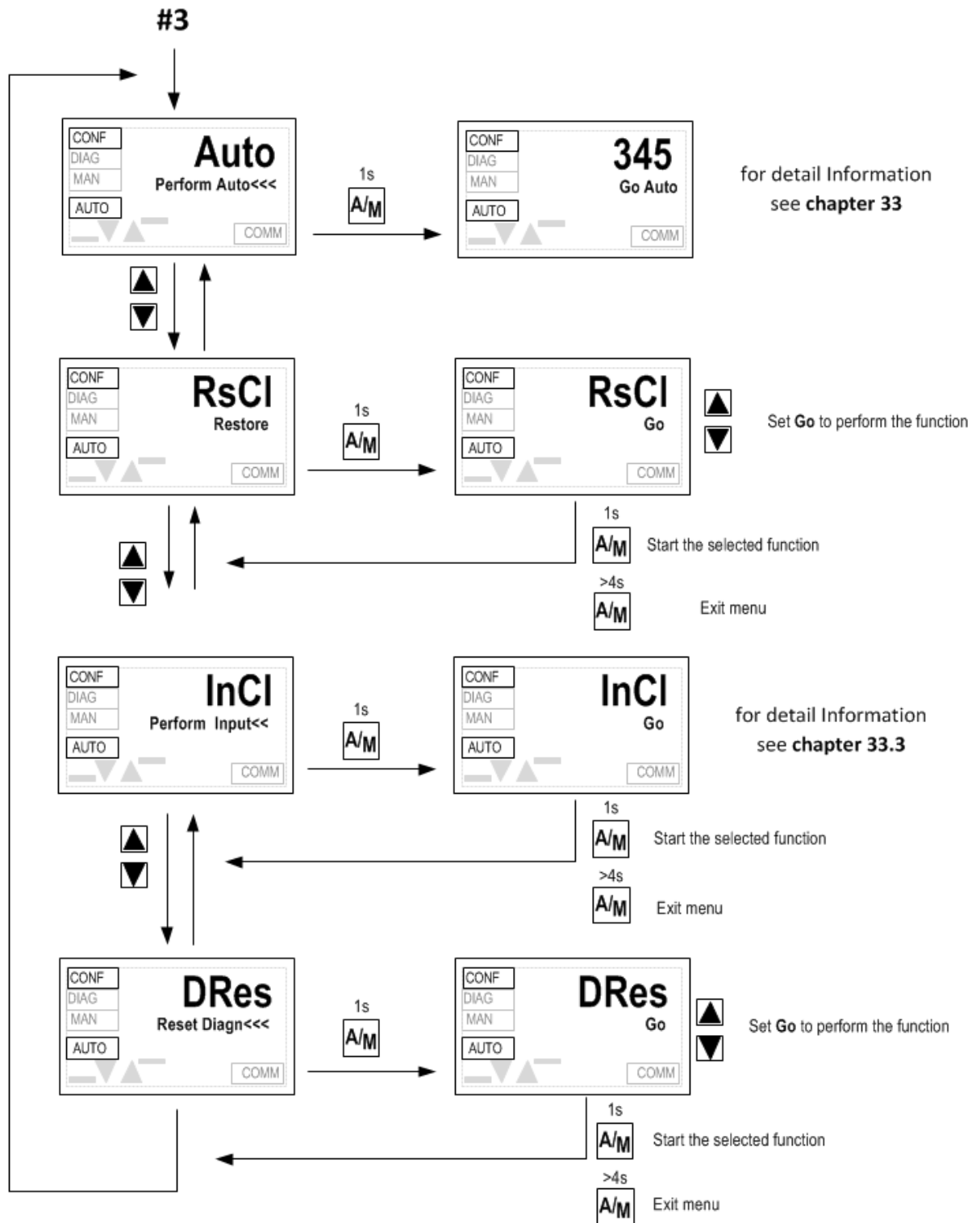

32. Commands

Commands			
#	Display	Description	Function
1	Auto	Perform Auto Initialization	Enter to the Initialization procedure
2	RsCI	Restore Last Autocalib Data	Restore the dead band to the value calculated by the last auto-Initialization procedure, user changes are canceled
3	InCI	Perform Input Calibration	Enter to the analog input calibration procedure
4	DRes	Reset Diagnostic Data	Reset of the diagnostic counters

32.1 Auto Initialization Procedure

The **Auto** item move to the sub-menu that manages the Initialization procedure, the user can select two auto initialization modes:

Full Auto: (Go Auto)

The user has just to move the actuator (by ▼ and ▲ key switches) round to middle of the total stroke.

The procedure moves the actuator to the full open and close limits and operates a series of movements in order to evaluate the characteristic of the actuator.



Pre- conditions required to start the Full Auto Initialization:

The actuator must be mounted and adjusted complete on the control valve. Limit switches open/ close must be adjusted regarding the real stroke of the control valve.

 pls. note cut off modes (limit or torque switch)



During the initialization, the limits of the actuator/ valve will be reached!!

It must be ensure that this can be performed without any risks.

Manual Limit Setting: (Go Man)

 pls. note: By using the **Manual Limit Setting** Function, the user has to ensure that the **Close Tight** Functions is disabled, otherwise an positioning error will be occurred, caused by over traveling the actuator limits (up/down)

The user has to move the valve first to the full open position (by ▼ and ▲ key switches), confirm (by **A/M** key switch) in order to store the position, then the same for the full close position. On the full close position confirm (by **A/M** key switch), the automatic procedure to evaluate the characteristic of the valve is started

On completion of the procedure the result is prompted to the user (Success or Failure) and the device waits for user acknowledge; pressing the **A/M** key switch the unit stores the new calibration data and exits to the normal operation mode if the procedure was successful, or back to the first step of the procedure.



Anytime long press (more than 4 sec) of the **A/M key switch** aborts the procedure and exits to the normal operation mode; no new data is stored.

32.2 Auto initialization procedure menu map

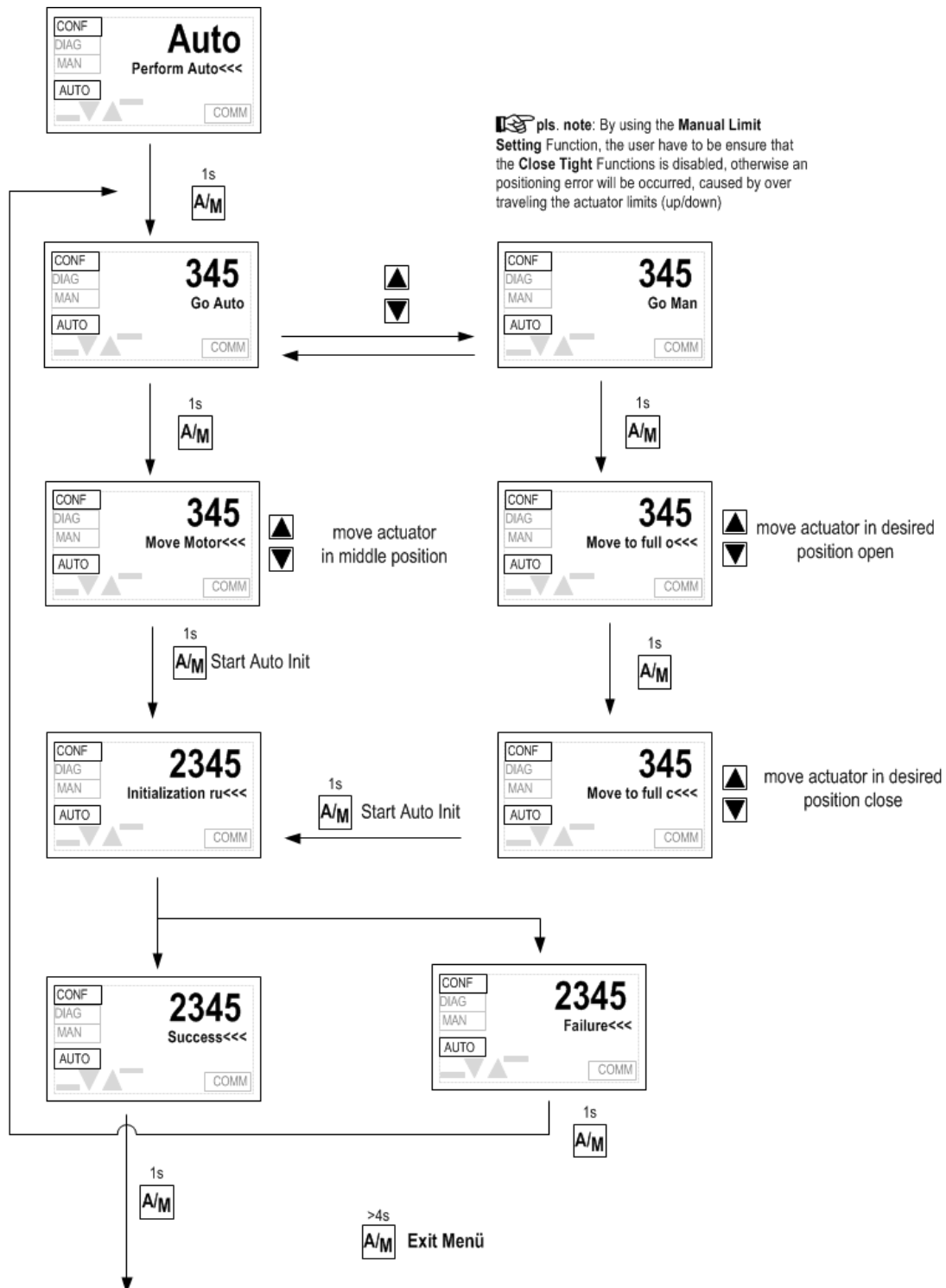

32.3 Input calibration procedure menu map

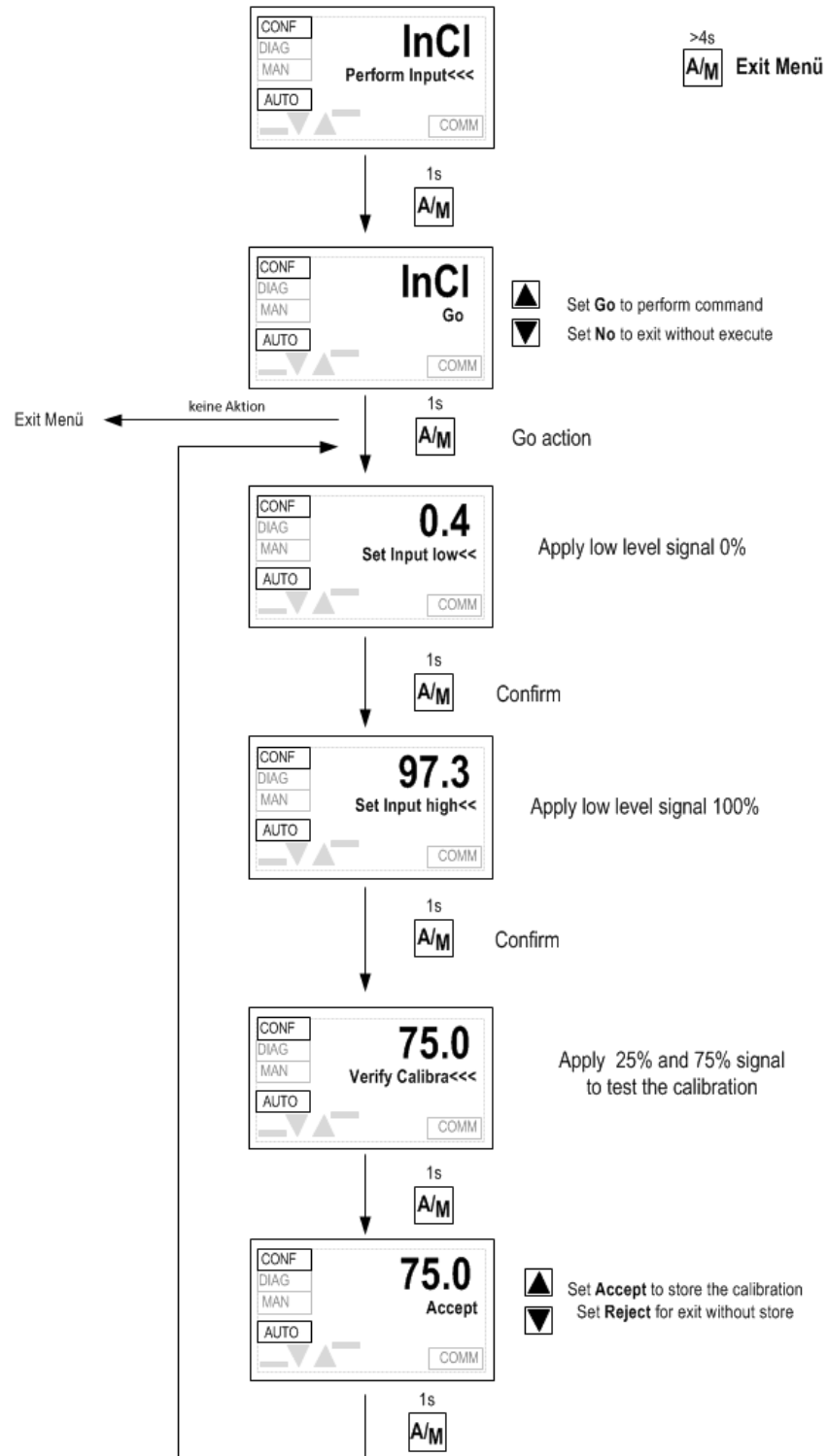

33. Setpoint vs Effective Actuator Direction (SpRv)

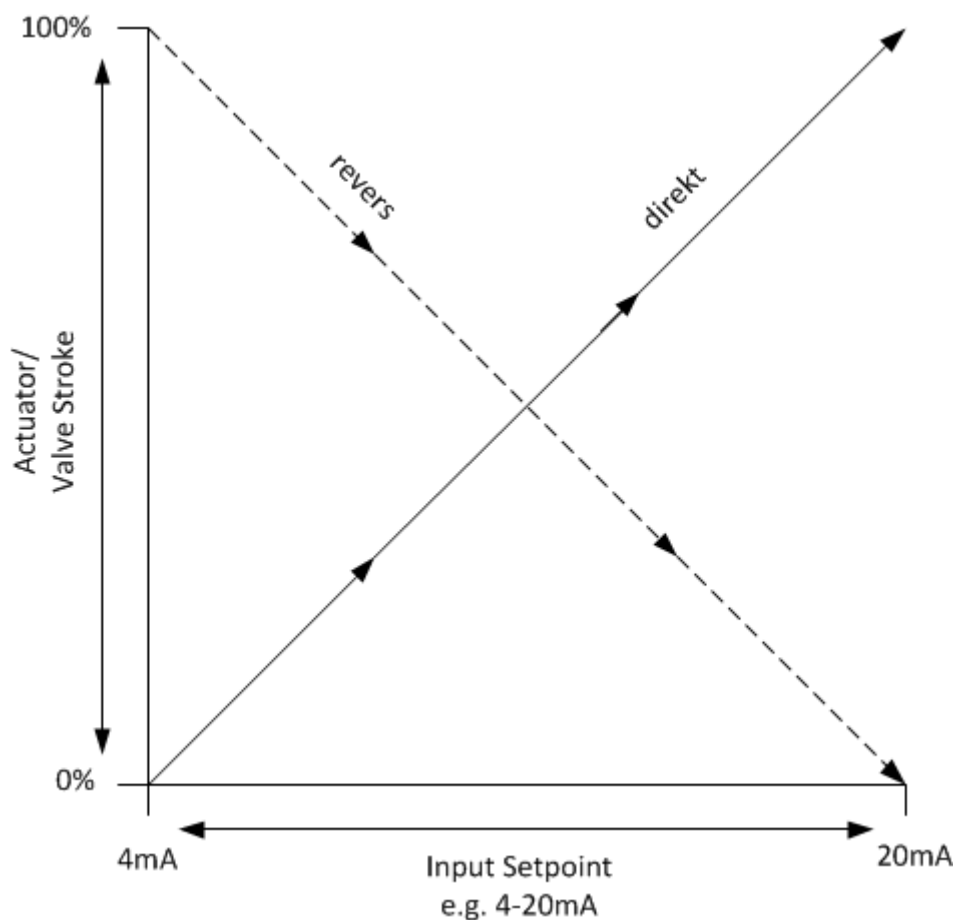

34. Split Range Mode (SplM)

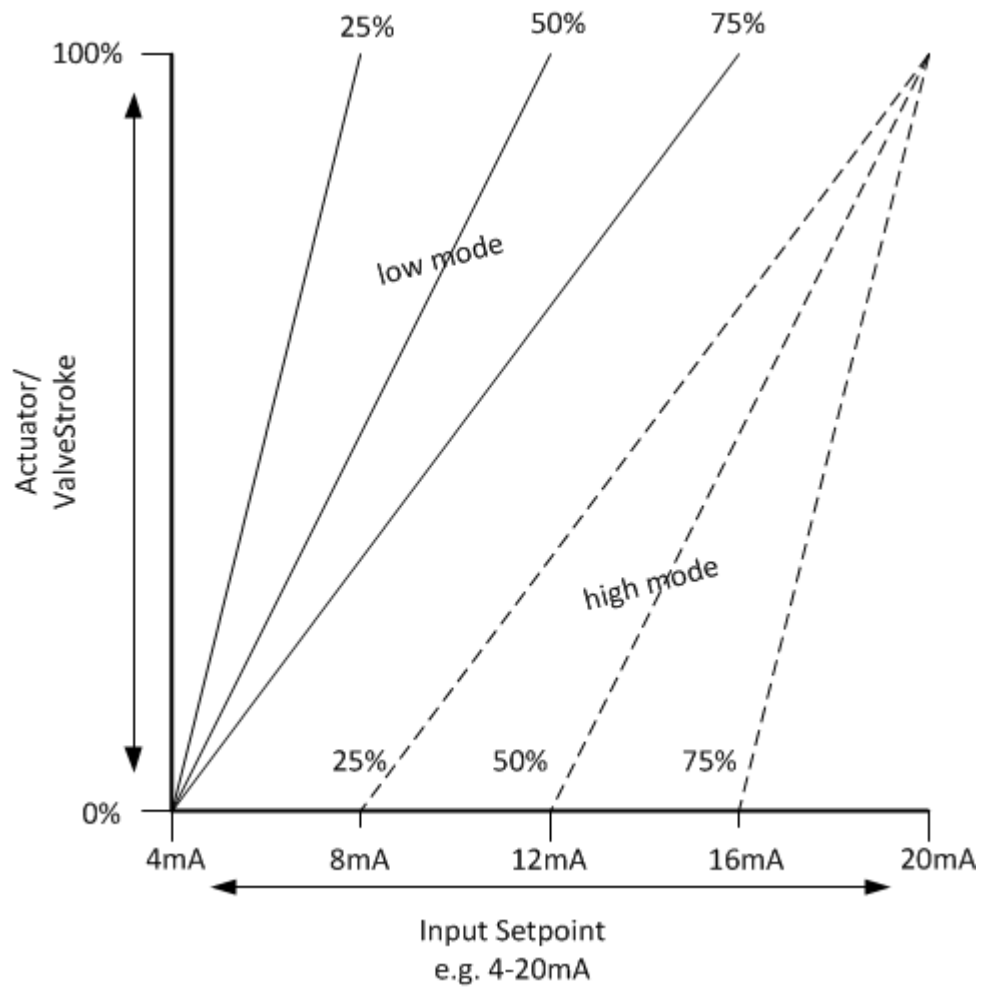

Display Split Range Mode

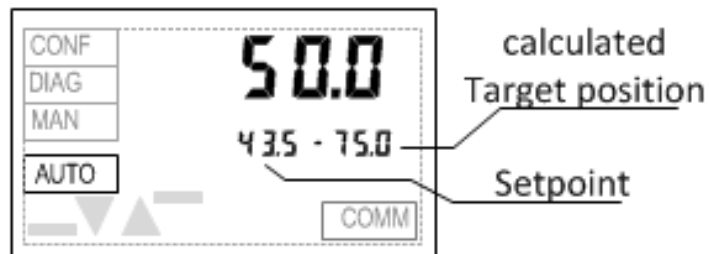

35. Setpoint vs Valve Stroke Characteristic (SpLn)

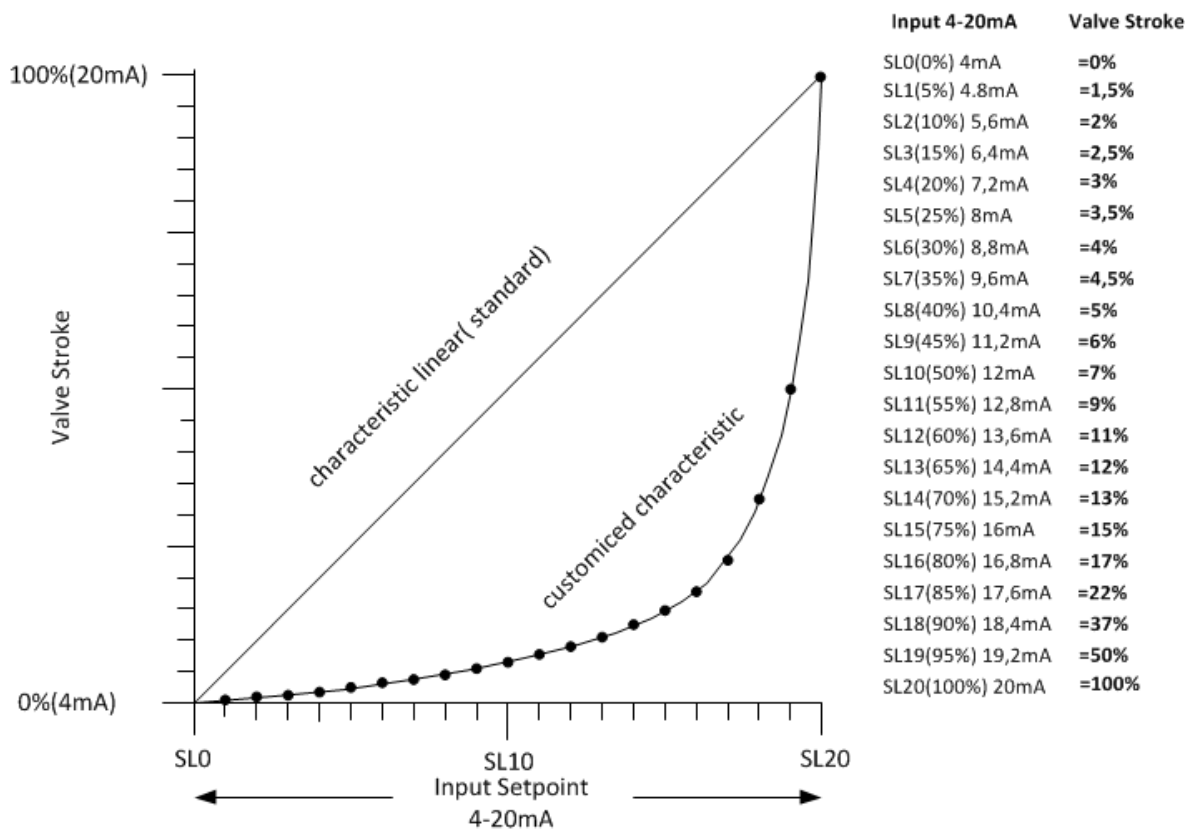

36. Close Tight Function (CITe)

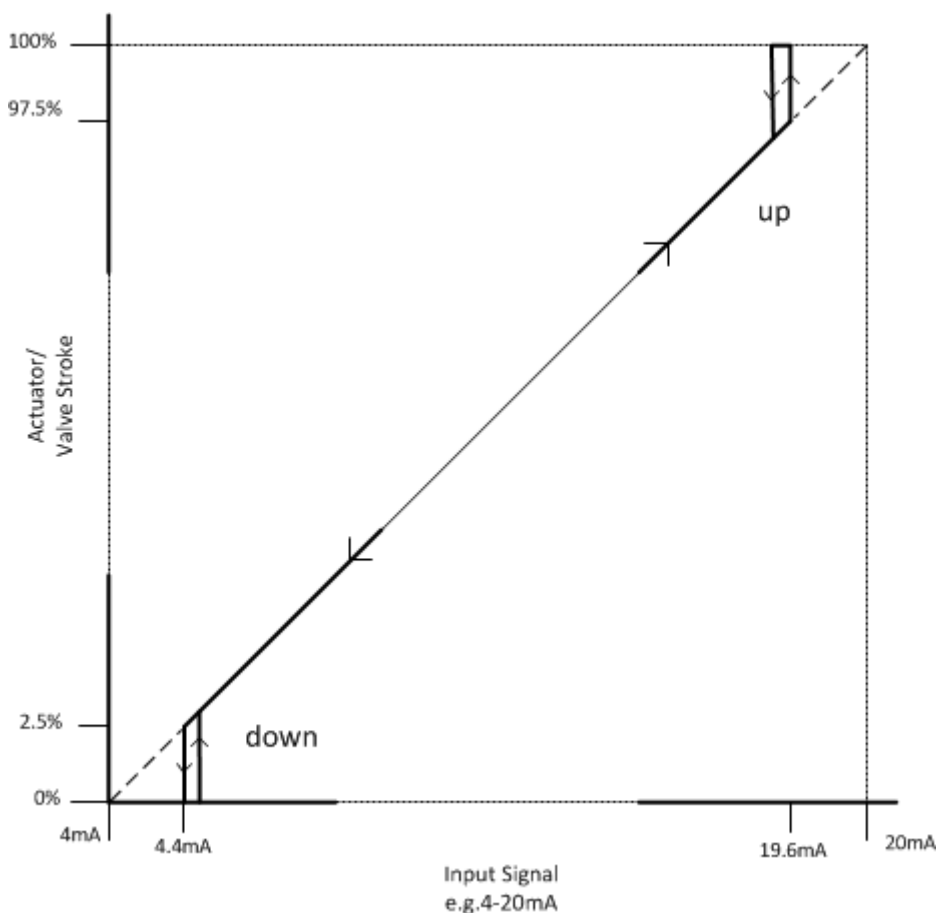

The Close Tight Function (default disabled) ensured that the actuator securely reached the limit positions up /down - (actuator switched off via limit or torque switch). Adjustable range: **0.5%...5.0%**.
The Close Tight Function operates always in both limit positions (up / down).

👉 pls. note: By using the **Manual Limit Setting** Function, the user have to be ensure that the **Close Tight** Functions is disabled, otherwise an positioning error will be occurred, caused by over traveling the actuator limits (up/down)

37. Minimum Travel Time Out (MnTT)

